

~~SECRET~~

PROJECT 1794
FINAL DEVELOPMENT SUMMARY REPORT
2 APRIL - 30 MAY 1956

USAF Contract No. AF33(600)30161

I. D. No. 56-RDZ-19954

AVRO AIRCRAFT LIMITED

**Baixado de
www.ateraplana.com.br**

DECLASSIFIED AT 10 YEAR
INTERVALS; NOT AUTOMATICALLY
DECLASSIFIED. DOD DIR 5200.10

DECLASSIFIED

Authority NND63253

SECURITY WARNING

This document is intended solely for the recipient and such persons as have been delegated to use it in the course of their duty and may be used in connection with work performed for or on behalf of the United States Air Force.

The transmission, unauthorized retention, destruction, or the revelation of its contents, in any manner, to (an) unauthorized person(s) is forbidden.

Failure to comply with any of the above instructions is an infraction of the Canadian Official Secrets Act and is a violation within the meaning of the United States Espionage Laws, title 18, U.S.C., sections 793 and 794.

This copy has been issued by Avro Aircraft Limited, Malton.

To -

Date -

Copy No. - **1**

Baixado de
www.aterraplana.com.br
siga @jadson_cr no instagram

I. D. 56 RDZ 19954

1 JUNE, 1956

~~SECRET~~

PROJECT 1794

FINAL DEVELOPMENT SUMMARY REPORT

2 April, 1955 - 31 May, 1956

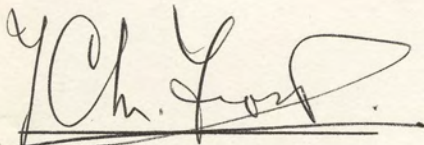
USAF Contract No. AF33(600)30161

Issued by:

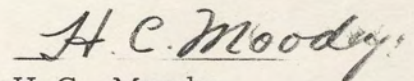
Avro Aircraft Limited
Malton, Ontario, Canada

Baixado de
www.aterraplana.com.br
siga @jadson_cr no instagram

Approved by:



J. C. M. Frost
Chief Design Engineer
Special Projects Group
Avro Aircraft Limited.



H. C. Moody
Engineering Manager
Special Projects Group
Avro Aircraft Limited.

The number of pages in this report, including the Title, Table of Contents and

Illustration sheets is 114

I. D. No. 56-RDZ-19954

1 JUNE, 1956

~~SECRET~~

TABLE OF CONTENTS

	<u>PAGE</u>
1. SUMMARY	1
2. INTRODUCTION	2
3. PROGRESS OF THE DESIGN	3
4. PROJECT 704	8
4.1 Description	8
4.2 Operation	11
4.3 Performance	15
5. DISCUSSION OF ACTIVITIES	20
5.1 Test Results	20
5.2 Design Study & Theoretical Analysis	74
6. FINANCIAL STATEMENT	87
7. DEVELOPMENT AND PRODUCTION ASPECTS	96
8. NEW PROGRAMS REQUIRED	98
8.1 Tests Program	98
8.2 Design Study and Theoretical Analysis	103
9. TABULATED SUMMARY & COST FORECAST	110

Baixado de
www.aterraplana.com.br
siga @jadson_cr no instagram

I. D. No. 56-RDZ-19954

1 JUNE, 1956

~~SECRET~~

i



FINAL DEVELOPMENT SUMMARY

1. SUMMARY

In this report the scope of work under the above contract is reviewed and the progress of the design is explained. An outline of the proposed research prototype which the contractor is building is then given, followed by the results of feasibility and performance potential studies for the subject aircraft, and a financial statement relating to the work accomplished.

It is concluded that the stabilization and control of the aircraft in the manner proposed - the propulsive jets are used to control the aircraft - is feasible and the aircraft can be designed to have satisfactory handling through the whole flight range from ground cushion take-off to supersonic flight at very high altitude. Supersonic tests show that the calculated thrust potential with the present design will provide a much superior performance to that estimated at the start of contract negotiations, with a top speed potential between Mach 3 and Mach 4, a ceiling of over 100,000 ft. and a maximum range with allowances of about 1,000 nautical miles.

Additional tests to completely substantiate this performance are shown to be required. Development and production aspects are briefly reviewed and an outline new program broader in scope than the study now completed is presented (to dovetail with the development envisaged), together with an accompanying cost estimate. This estimate covers a period of 18 to 24 months in the total amount of \$3,168,000.

2. INTRODUCTION

The work statement - Exhibit 1 of the above contract - specifies "analytical investigations and design studies to determine the performance capabilities and design features of a flat vertical take-off and landing aircraft", of a new type proposed by AVRO AIRCRAFT LIMITED: together with substantiating tests. This contract is essentially a feasibility study and "design configuration effort shall be confined to the minimum required for demonstration of principles in a practical application". The areas for test and analysis are defined as:

- (1) Air Cushion effect
- (2) Stability of multi-engine configuration
- (3) Air Intake and gas exhaust system test
- (4) Aircraft performance, stability and control
- (5) Radial flow engine feasibility

The progress of work has been reported in detail in ten monthly progress reports of which the first group were summarized in an interim development summary report. The whole period is covered by this final development summary and the work under this contract is now completed.

Separate technical reports have been prepared on each of these five areas, plus three further separate reports covering wind tunnel model tests. A general technical summary I. D. No. 56RDZ-13709 reviews all the work done during the year from the technical standpoint and outlines the current status of the design.

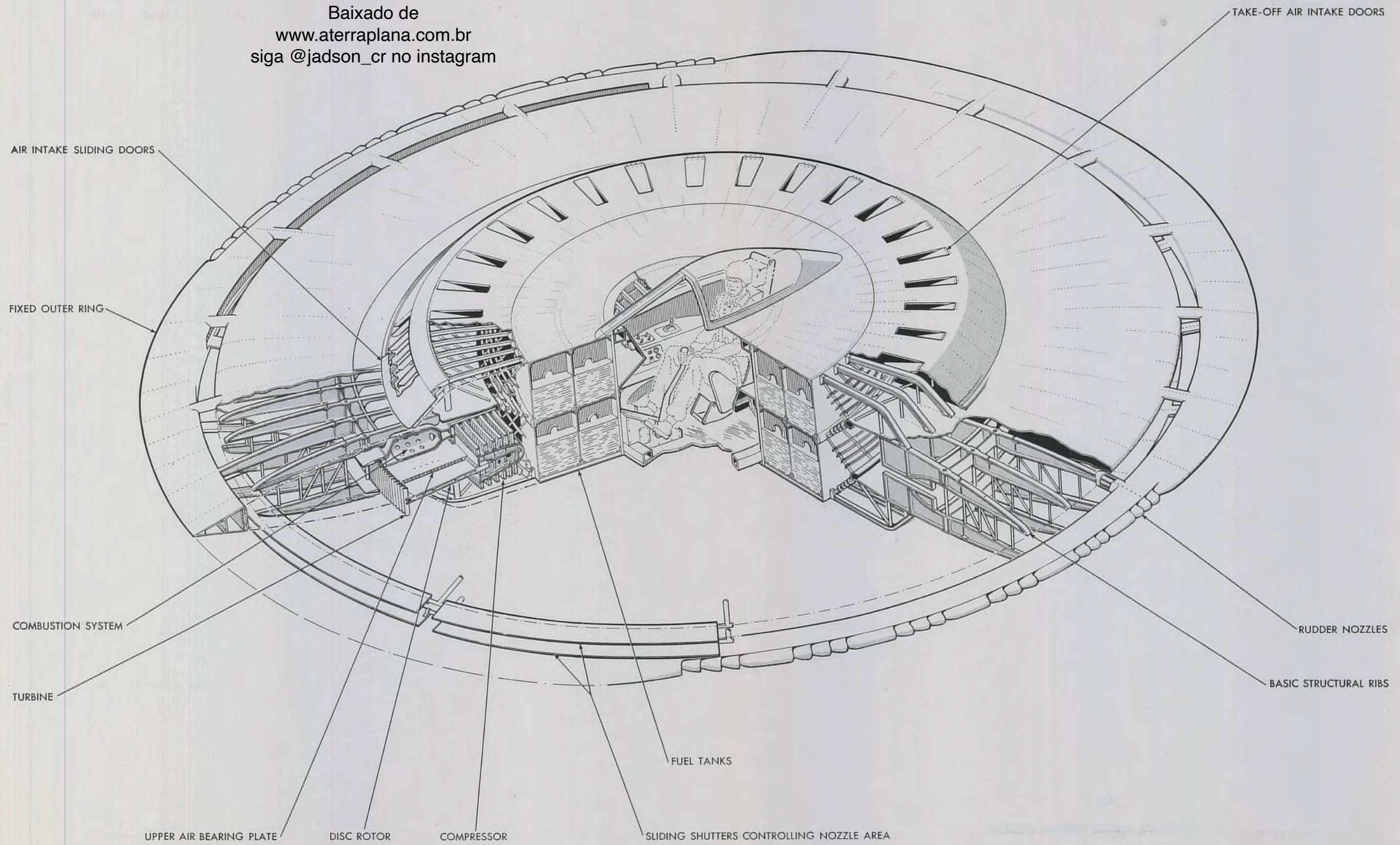
3. PROGRESS OF THE DESIGN

At the start of contract negotiations the proposed design (Fig. 1 on the following page) was for a jet-propelled all-wing aircraft of circular planform, embodying a new arrangement of a turbo-jet engine and employing jet control. In order to separate the engine development task from that of the airframe an intermediate research vehicle employing 8 small conventional turbo-jets radially disposed like the spokes of a wheel was also proposed at this time (Fig. 2). An alternative final development to the large radial engine of Fig. 1 was also suggested (Fig. 3).

At the beginning of the contract period a compromise between the Fig. 1 and Fig. 3 designs was conceived, having a superior performance to either. This ducted fan arrangement - while preserving the radial flow and circular planform with air cushion VTOL, avoided some considerable objections to the earlier designs and also gave good static thrust-lift efficiency and a very thin wing, using the entire depth of the wing between skins for engine air flow. This design was developed under contract area (5) through several mechanical arrangements to the form shown in Fig. 4 and has supplanted the earlier designs. In view of the relatively minor task of developing the main rotors of Fig. 4 by comparison with the engine of Fig. 1, the idea of an intermediate vehicle has been discarded and AVRO AIRCRAFT LIMITED is proceeding with the construction of the aircraft illustrated in Fig. 4, which is described in general terms in the next section.



Baixado de
www.aterraplana.com.br
siga @jadson_cr no instagram



AVRO

AIR INTA

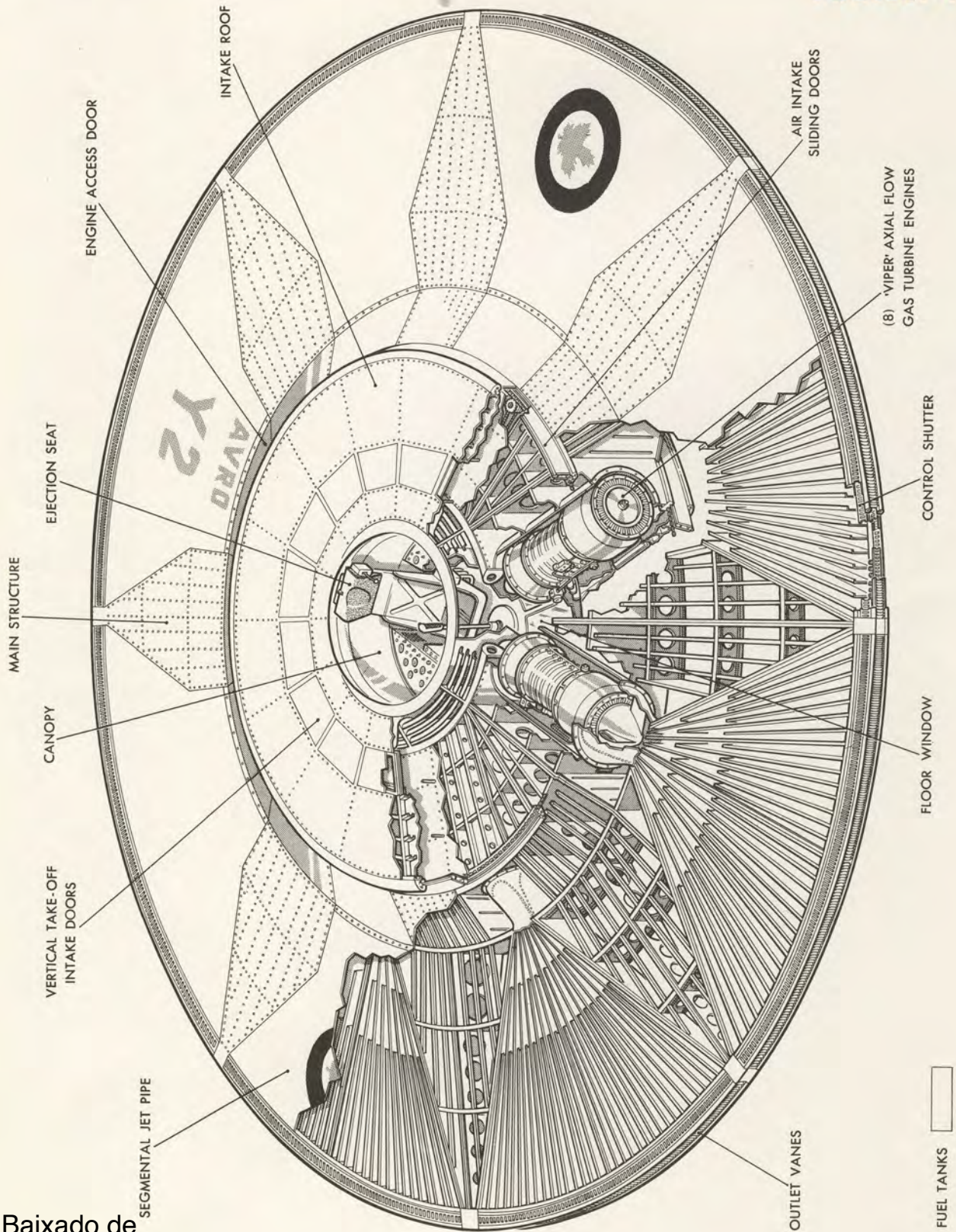
FIXED OU

COMBUST

TURBINE

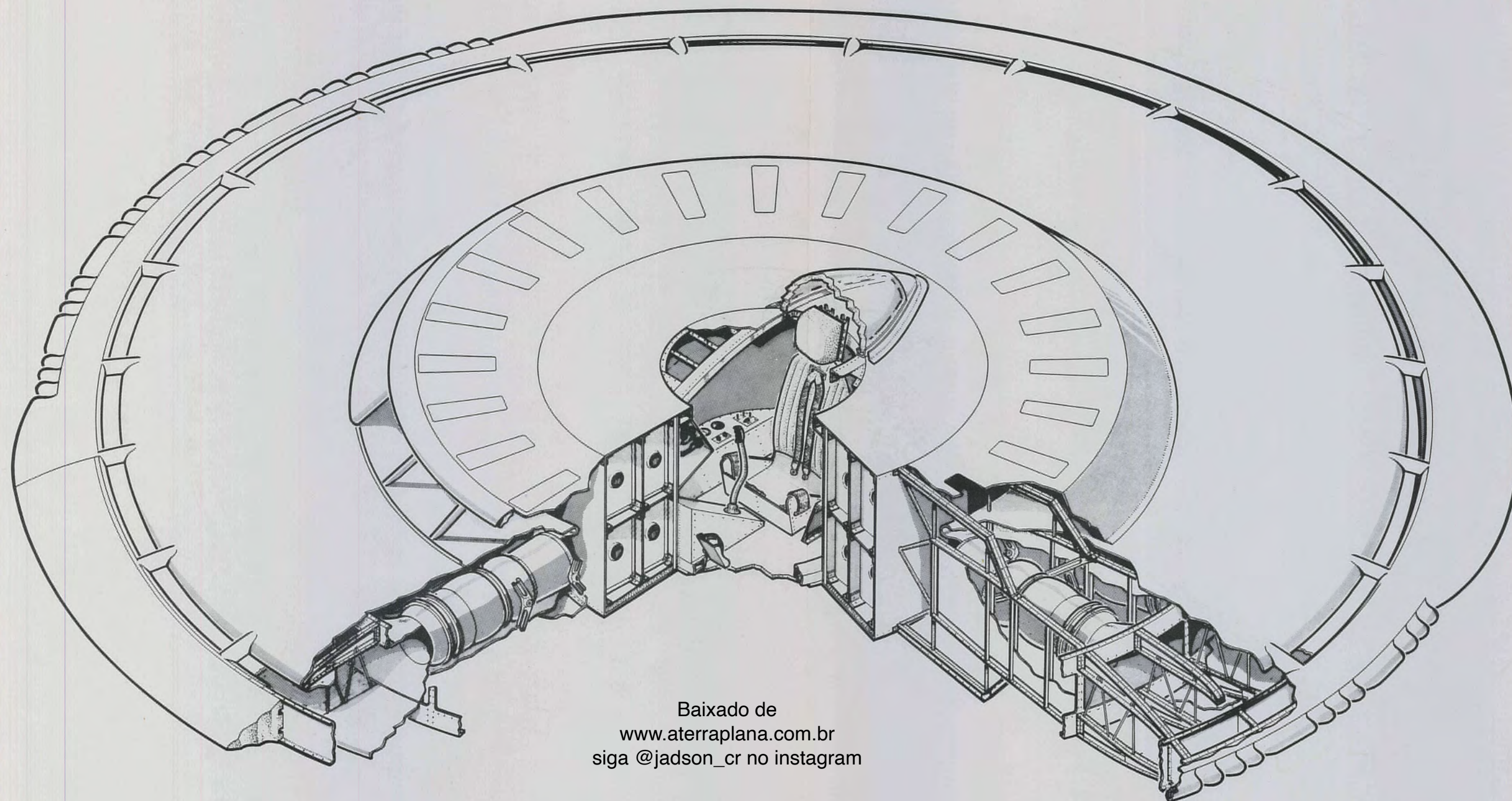


FIG. 1
ORIGINAL RADIAL ENGINE DESIGN



Baixado de
www.aterraplana.com.br
siga @jadson_cr no instagram

FIG. 2 INTERMEDIATE RESEARCH AIRCRAFT



Baixado de
www.aterraplana.com.br
siga @jadson_cr no instagram

FIG. 3 SECTION CUTAWAY - CONVENTIONAL GAS TURBINE POWER PLANT SUBSTITUTION

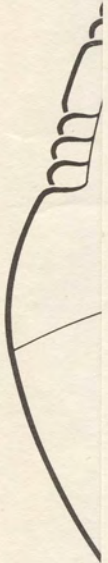
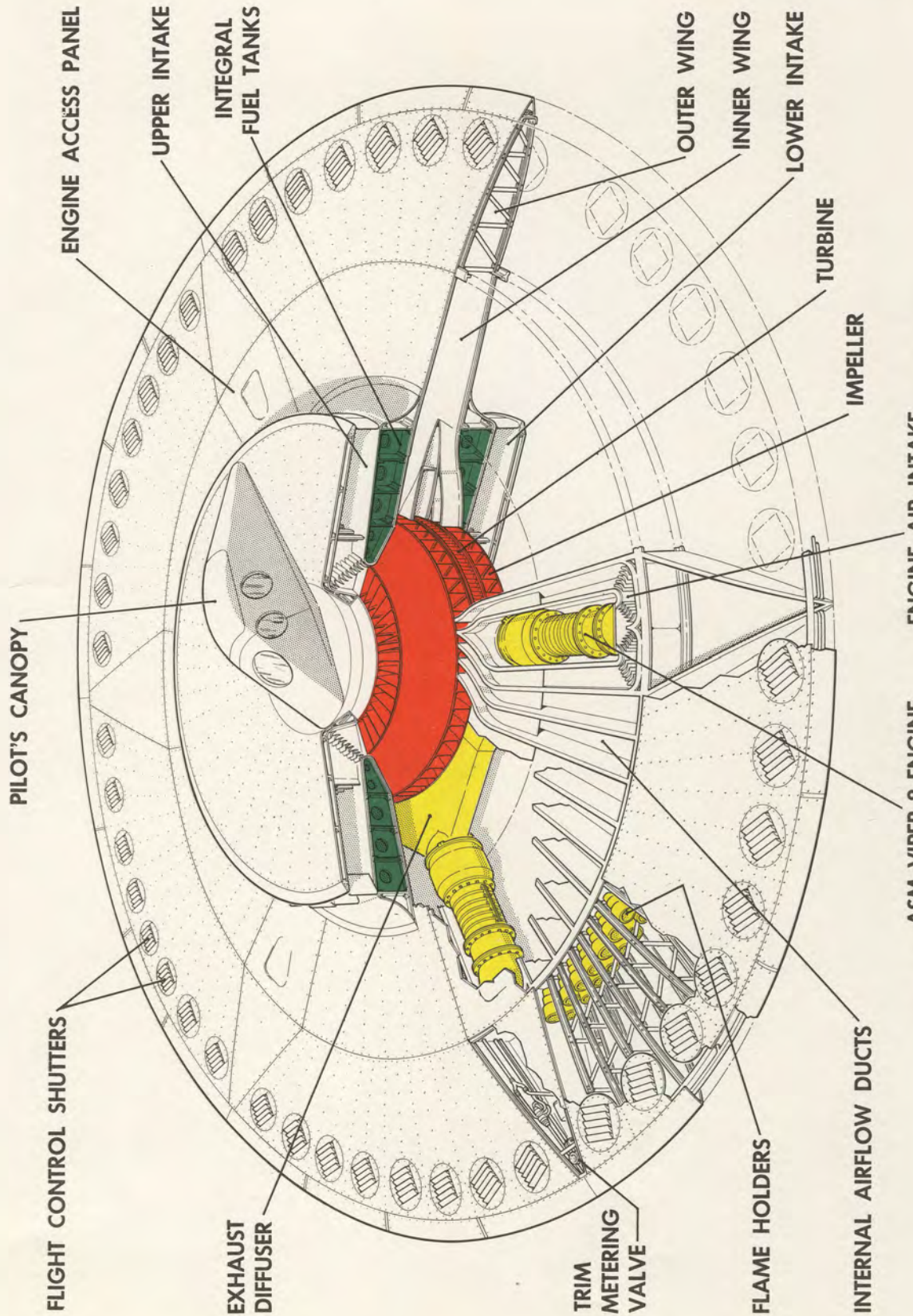


FIG. 3 SECTION CUTAWAY - CONVENTIONAL GAS TURBINE POWER PLANT SUBSTITUTION



6-VIPER DUCTED FAN RAMJET DESIGN
FIG. 4

4. PROJECT 704

To distinguish it from the work covered under contract on Project 1794 the undertaking to build the aircraft is known by AVRO AIRCRAFT LIMITED as Project 704.

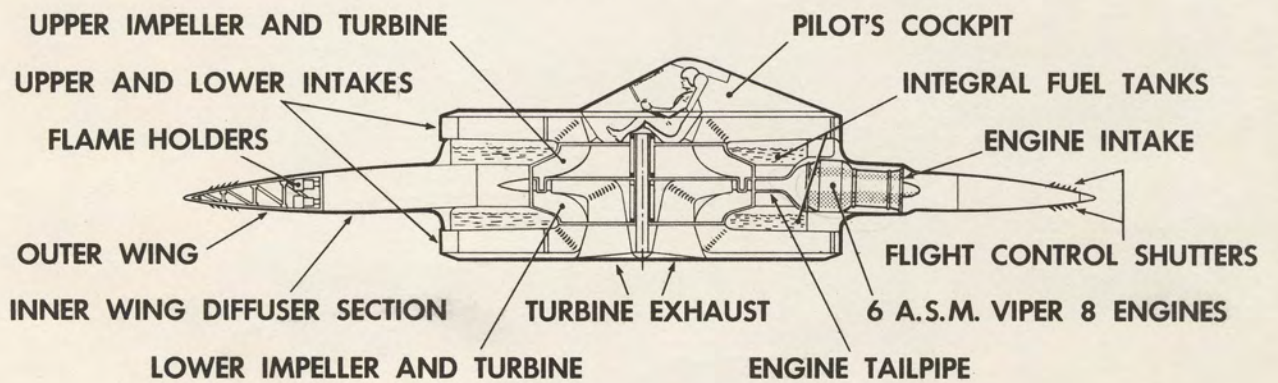
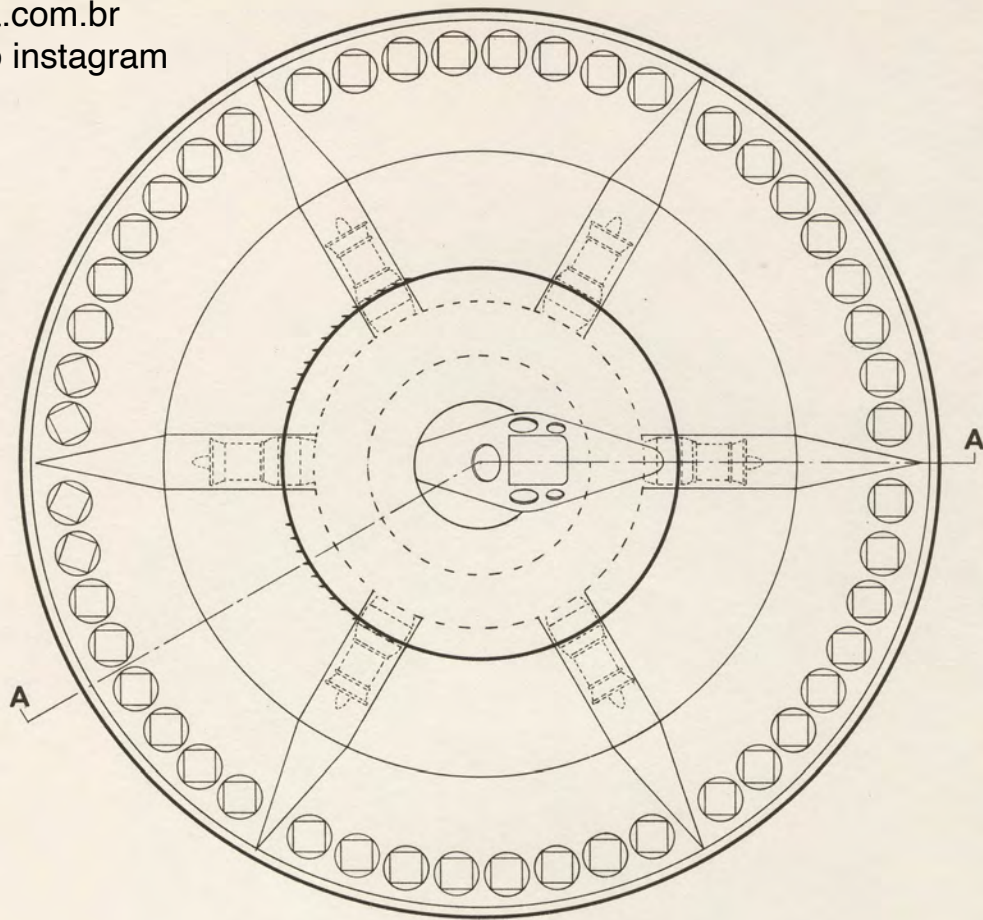
4.1 Description

Fig. 5 is a plan and section drawing of the aircraft. It is 35.3 feet in diameter; stands about 2 feet off the ground, measures 7.7 feet from the lower surface to the top of the canopy; is approximately symmetrical in section and is expected to weigh about 20,000 lb. with 5,700 lb. fuel. The maximum fuel capacity is 13,150 lb. giving a maximum weight of about 27,000 lb.

Six Armstrong Siddeley Viper turbo-jets - 1,900 lb. thrust, 22.0" overall diameter, 525 lb. weight each - are mounted radially in the wing, exhausting inwards; and used as gas generators to drive a pair of contra-rotating centrifugal impellers by means of a radial inflow turbine.

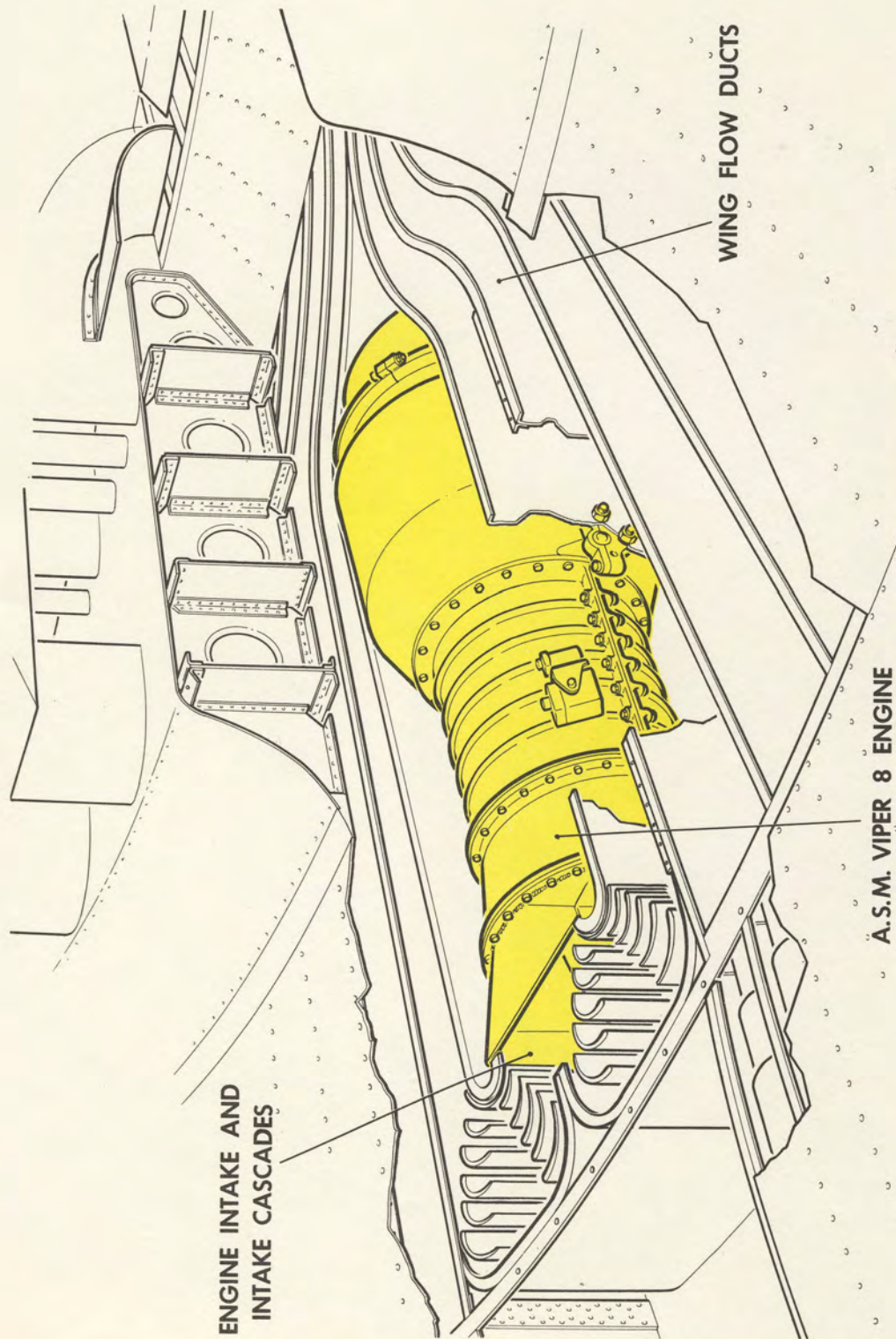
The 8 foot diameter impellers, which rotate slowly by comparison with conventional centrifugal turbo-jets, draw air from the upper and lower intakes and force it radially out through the wing between the Viper engines. Some of the air thrown out by the impellers is directed back to feed the Viper engines (Fig. 6), which thus behave statically as though there was ram pressure from forward flight on their air intakes.

Baixado de
www.aterraplana.com.br
siga @jadson_cr no instagram



**PLAN VIEW AND SECTION THROUGH AIRCRAFT
FIG. 5**

Baixado de
www.aterraplana.com.br
siga @jadson_cr no instagram



**ENGINE INSTALLATION
FIG. 6**

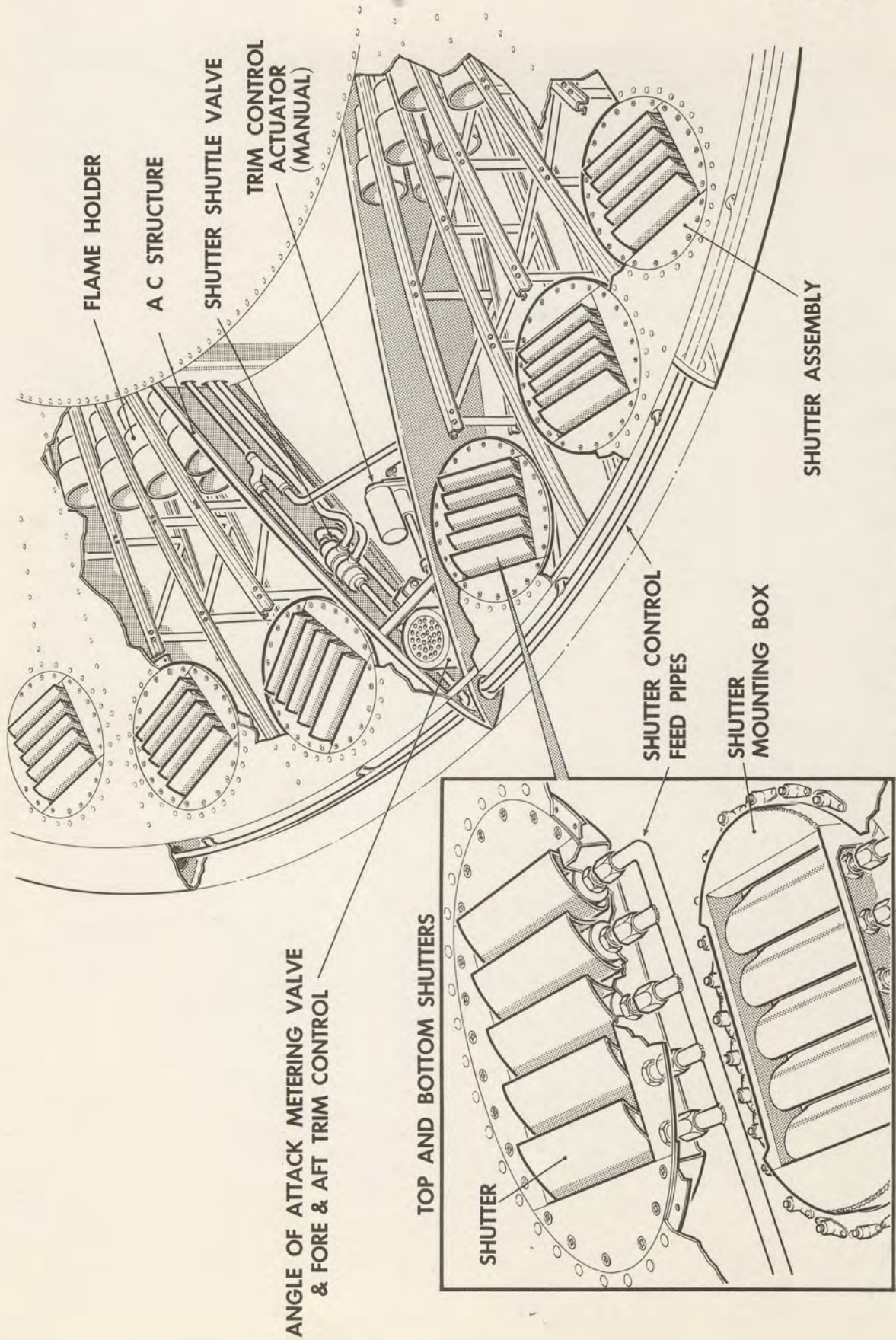


4.1
(Cont'd)

The air is diffused in the wing to a high pressure at the flame holders (Fig. 5), where fuel may be added to augment the thrust, and is then exhausted through pneumatically controlled shutters or gills (Fig. 7) which direct the jet as it exhausts all around the aircraft periphery; either to raise the aircraft vertically off the ground or to propel it in forward flight. This control of the exhaust direction enables the jets to be used for manoeuvring and stabilizing the aircraft in all flight conditions, so that separate additional controls are not required to cater for vertical take-off and hovering. Thus, for instance, to pull up the nose of the aircraft the pilot will control the shutters by means of a conventional cockpit stick control to direct the jet out at the top of the wing in the rear sector and thrust the tail down, or to roll he will similarly direct the jet from the top on one wing and from the bottom on the other. For stabilizing, the main rotors and a diaphragm are used to sense when the aircraft pitches in a gust and use is made of the jet controls to correct it. Stabilization through the controls is essential on this aircraft since the centre of gravity is in the middle of the wing at $1/2$ the chord from the leading edge, whereas the aircraft would only be stable without using the controls if the centre of gravity were about at the $1/4$ chord position. The change in jet direction as the aircraft pitches performs the same function as the fixed stabilizer of a conventional aircraft.

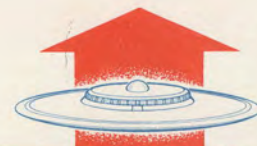
4.2 Operation

To take off, all the shutters on top of the wing are closed and shutters



CUTAWAY OF CONTROL SHUTTERS
FIG. 7

1.474-704-1



4.2
(Cont'd)

on the bottom are opened wide. Without adding fuel to augment it, about 20,000 lb. thrust is produced by the jets pointing downwards all around the wing; however this jet-around-wing configuration produces a powerful take-off ground cushion so that the lift on the aircraft is, in fact, increased to possibly 30,000 lb., and the aircraft rises to about 20 feet (Fig. 8), where the ground cushion effect falls off rapidly. For pure vertical take-off the thrust must now be augmented and the exhaust arrangement modified by the pilot: however, it is envisaged that transition to forward flight will normally be from the ground cushion. By operating a transition control the pilot leans the jets backwards gradually to accelerate the aircraft, and raises the nose; with the thrust less than the weight, the aircraft can accelerate and rise into free air a short distance from the starting point.

In forward flight ram pressure is collected into the air intake which increases the pressure at the flame tubes and makes burning more efficient. At supersonic speed augmentation is always used and because of the large mass of air the impellers can handle, a very large thrust and high top speed is possible. The large installed thrust also leads to a high thrust to weight ratio which makes a very high ceiling possible. The efficiency of the airframe at supersonic speed appears good and that of the engine reasonable, so that a long supersonic cruise range is also forecast.

For landing, either a fully vertical descent may be made, with or

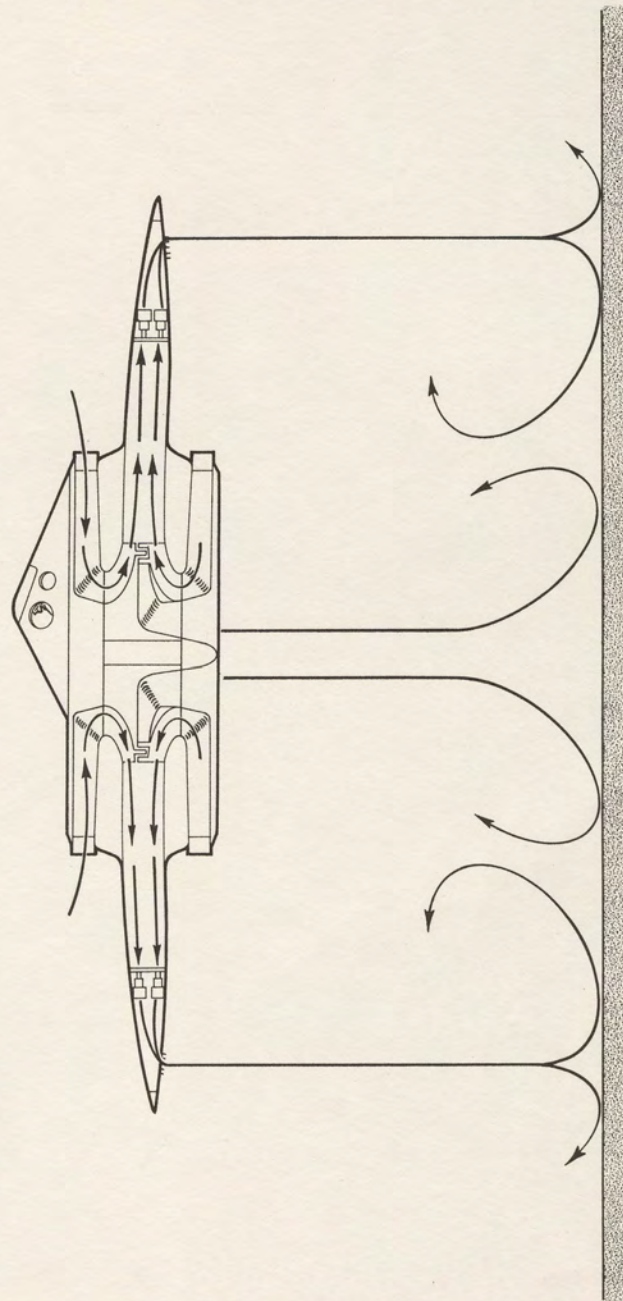


FIG. 8 GROUND CUSHION EFFECT

4.2
(Cont'd)

without thrust augmentation from a hot main jet, or a steep approach path to the ground chosen. Transition to the landing condition from in-flight is similar to the take-off transition. The nose is raised and the jets transferred to the undersurface and leaned forward collectively to rapidly slow the aircraft down; as the speed falls close to zero the nose is lowered to bring the aircraft into the fully hovering condition. On sinking into the ground cushion the pilot must then close the throttle to reach the ground.

4.3 Performance

The performance of the first prototype will initially be restricted due to a Mach No. restriction on the Viper engines. The following summary assumes this restriction has been removed:

At 1200°K main combustion temperature,

Max. level speed (Fig 9) Mach 3.0

Supersonic ceiling (Fig 10) 94,000 feet

Altitude for normal acceleration

of 7.33g in a steady turn 53,000 feet

Still air range (full internal fuel)

with allowances for take-off climb and

acceleration, cruising at Mach 2.25 at

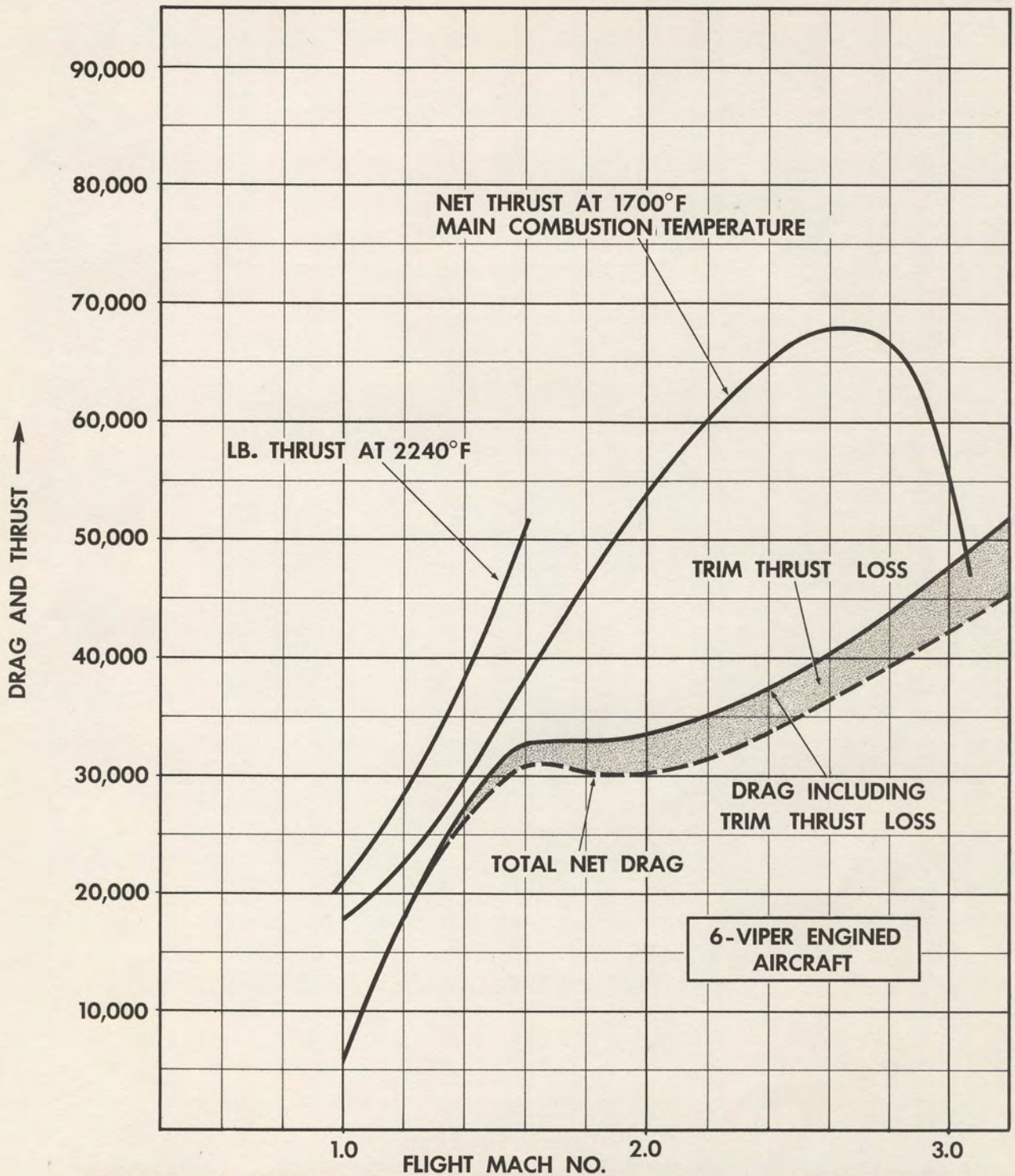
90,000 feet (Fig 11) 1,000 naut.
miles



4.3
(Cont'd)

Take-off and landing

VTOL



PROJECT 1794 DRAG AND THRUST vs MACH NO. 35,300 FT.
FIG. 9

1553-704-2

ALTITUDE
FT

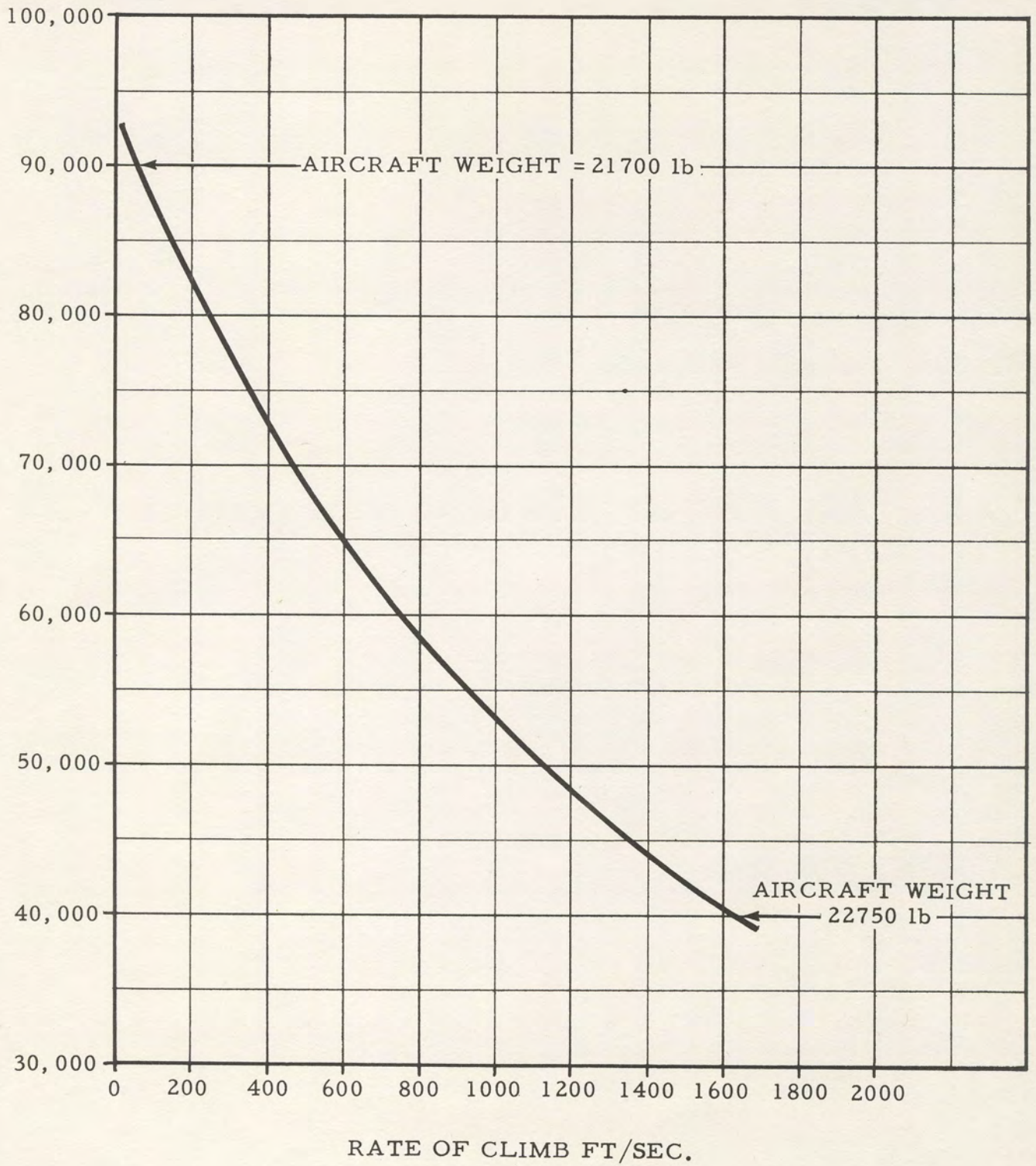


FIG. 10 PROJECT 1794 RATE OF CLIMB AT MACH 2.26

~~SECRET~~

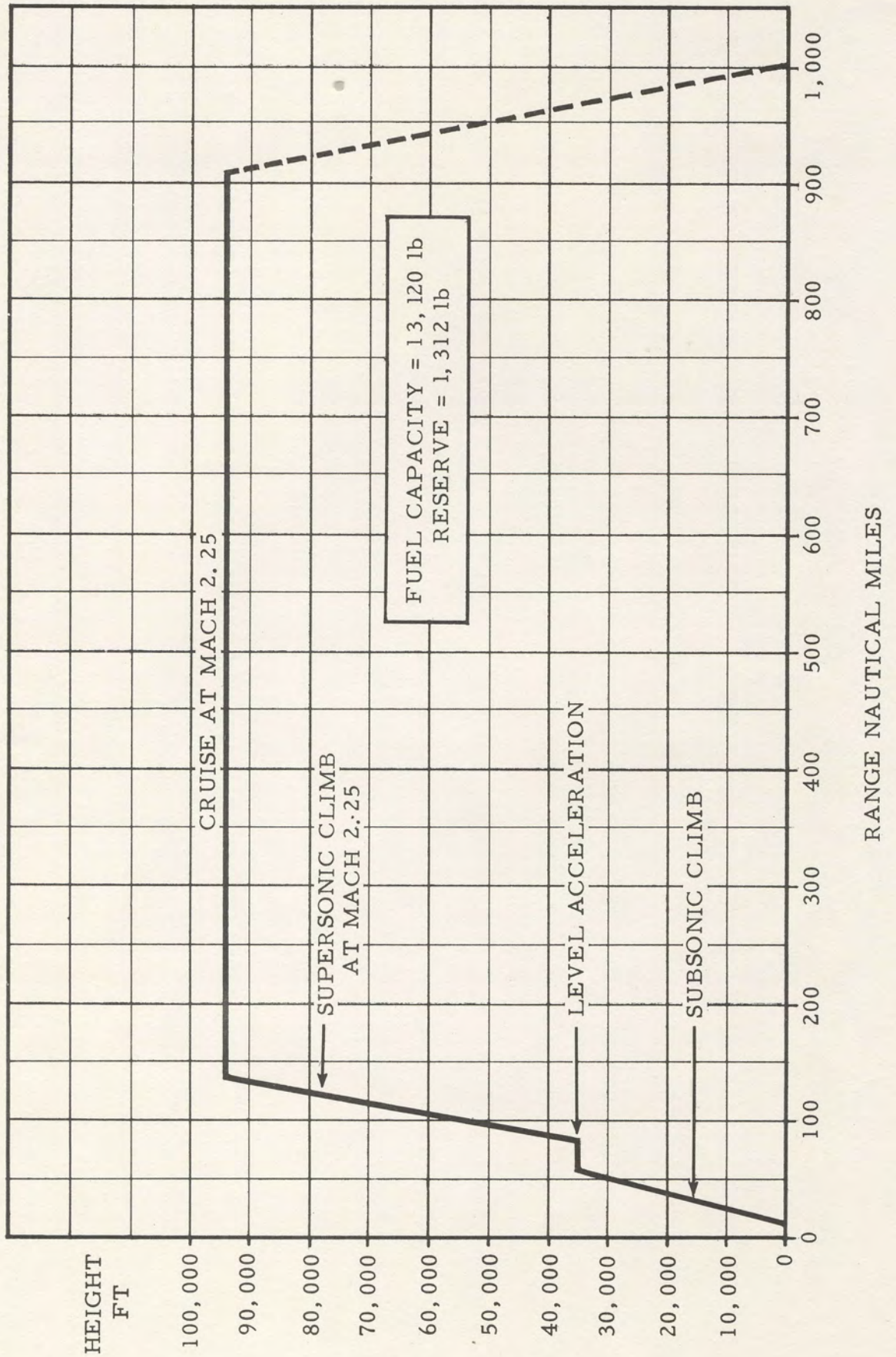


FIG. 11 PROJECT 1794 STILL AIR RANGE

~~SECRET~~

5. DISCUSSION OF ACTIVITIES

5.1 Tests

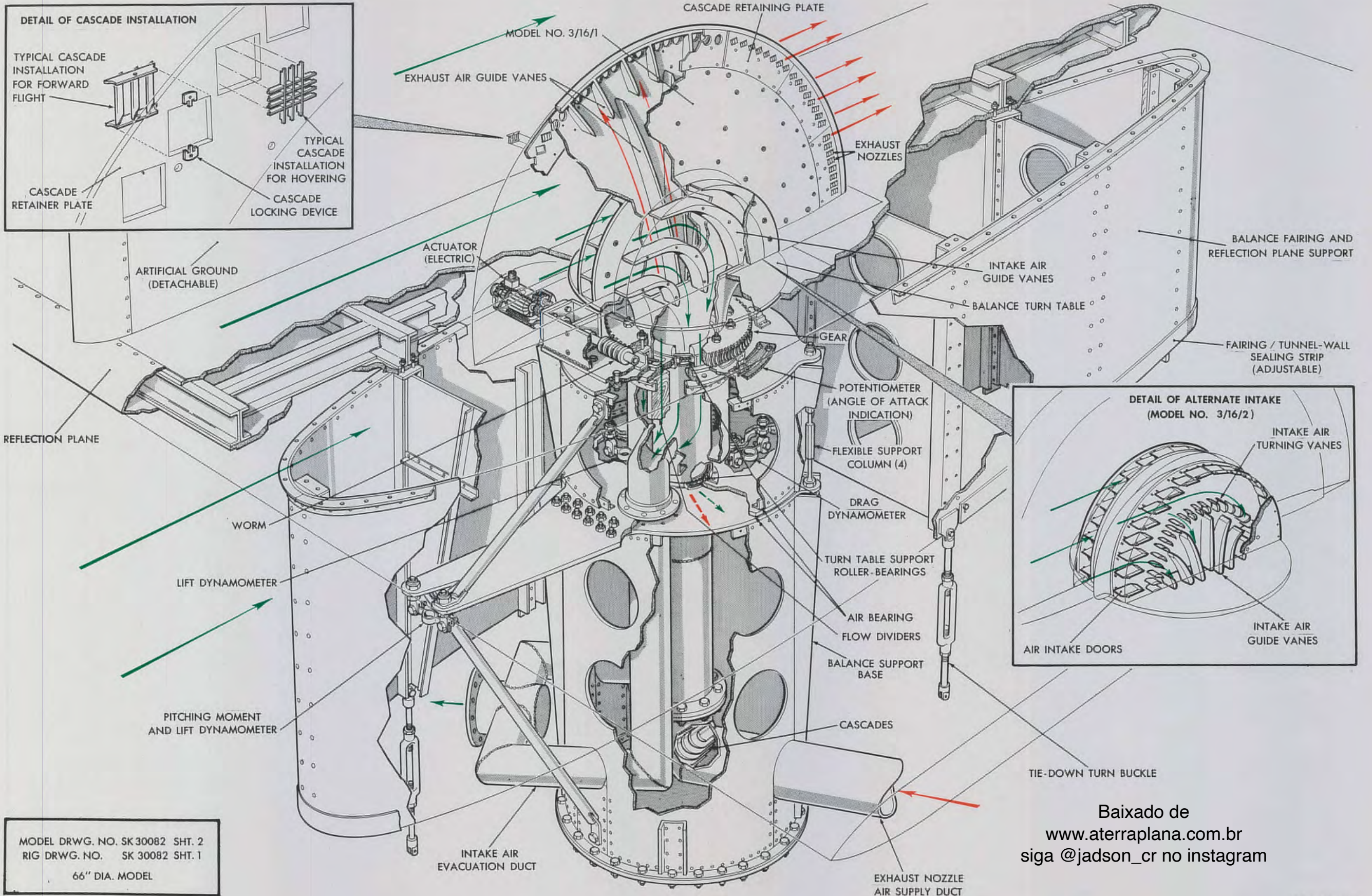
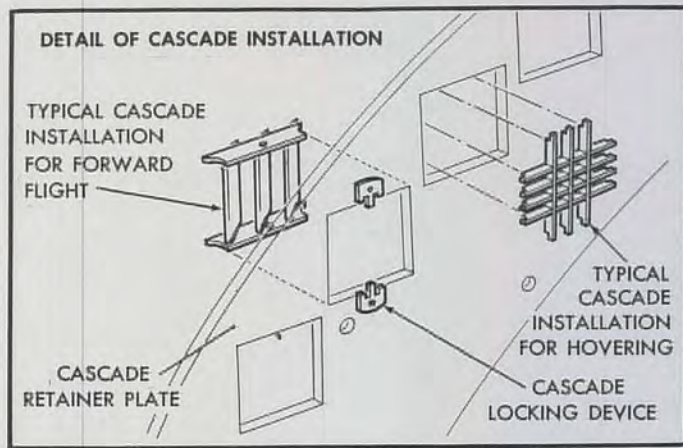
A tabular summary of the following is given at the end of this report

5.1.1 Wind Tunnel Tests: A program of wind tunnel testing has been carried through during the year in three groups as follows:

5.1.1.1 An important series of subsonic tests, involving over 500 hours testing time and 34 weeks tunnel occupancy has been carried out on a 1/6th scale* reflection plane model. In these tests, which were done in the 20 ft. diameter Massie Memorial Wind Tunnel at Wright Air Development Centre, provision was made for simulating air intake and jet exhaust flows. Fig. 12 is an illustration of the model, Figs. 13, 14 and 15 are photographs of the model and associated equipment. Testing covered all phases of subsonic operation, including static ground cushion effect tests with control, transition to forward flight with control in proximity to the ground and in free air, and in-flight tests with control in free air.

* NOTE: The geometry of Project 704 is slightly different to that of the wind tunnel models tested, which were based upon an earlier layout of an aircraft 33 feet dia. with $3\frac{1}{2}\%$ thickness/chord ratio wing. Corrections have been made to the performance quoted to account for the difference.

~~SECRET~~



MODEL DRWG. NO. SK 30082 SHT. 2
 RIG DRWG. NO. SK 30082 SHT. 1
 66" DIA. MODEL

1243-1794-1

Baixado de
www.ateraplana.com.br
 siga @jadson_cr no instagram

APRIL 27, 1956

STABILITY AND CONTROL MODEL NO. 2/16

~~SECRET~~

DE
TYP
INS
FOR
FLIC
RET

REFLE

MC
RI
1243-1

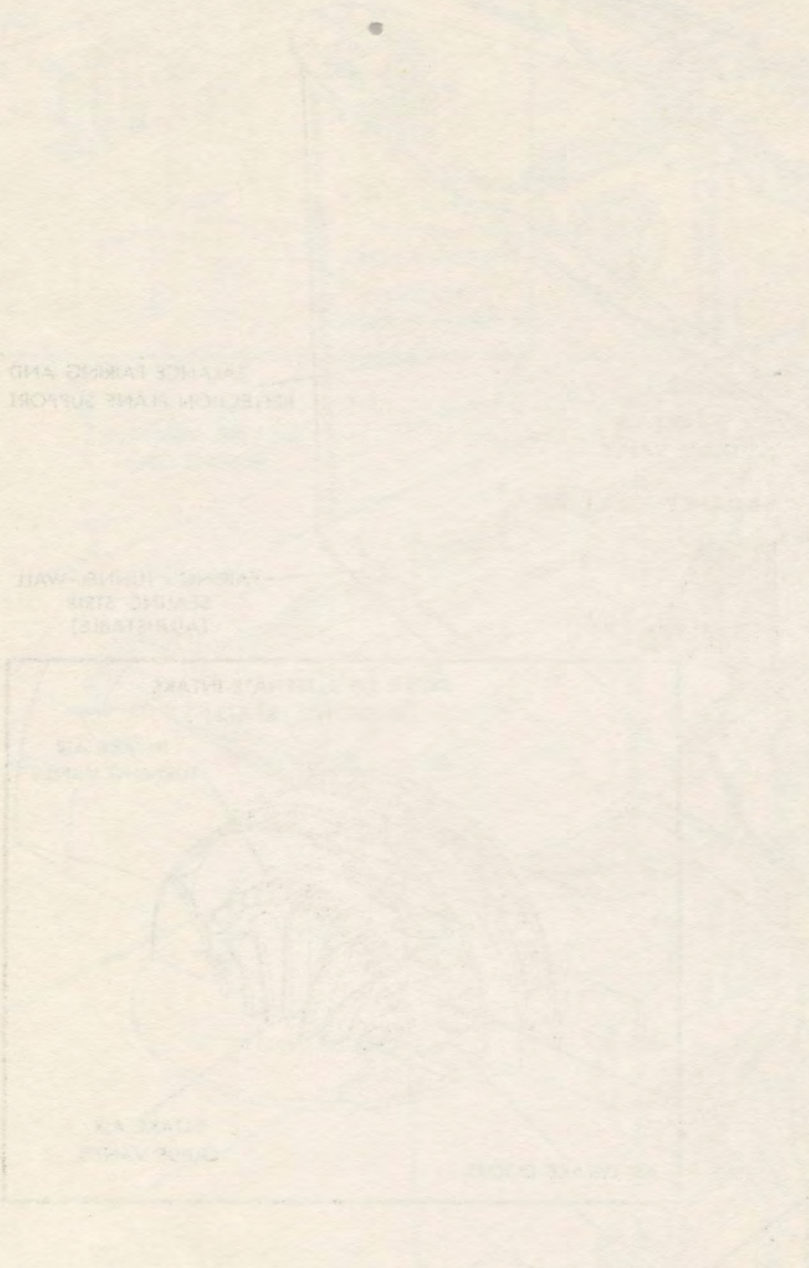


FIG. 12
STABILITY AND CONTROL MODEL NO. 2/16

Baixado de
www.aterraplana.com.br
siga @jadson_cr no instagram

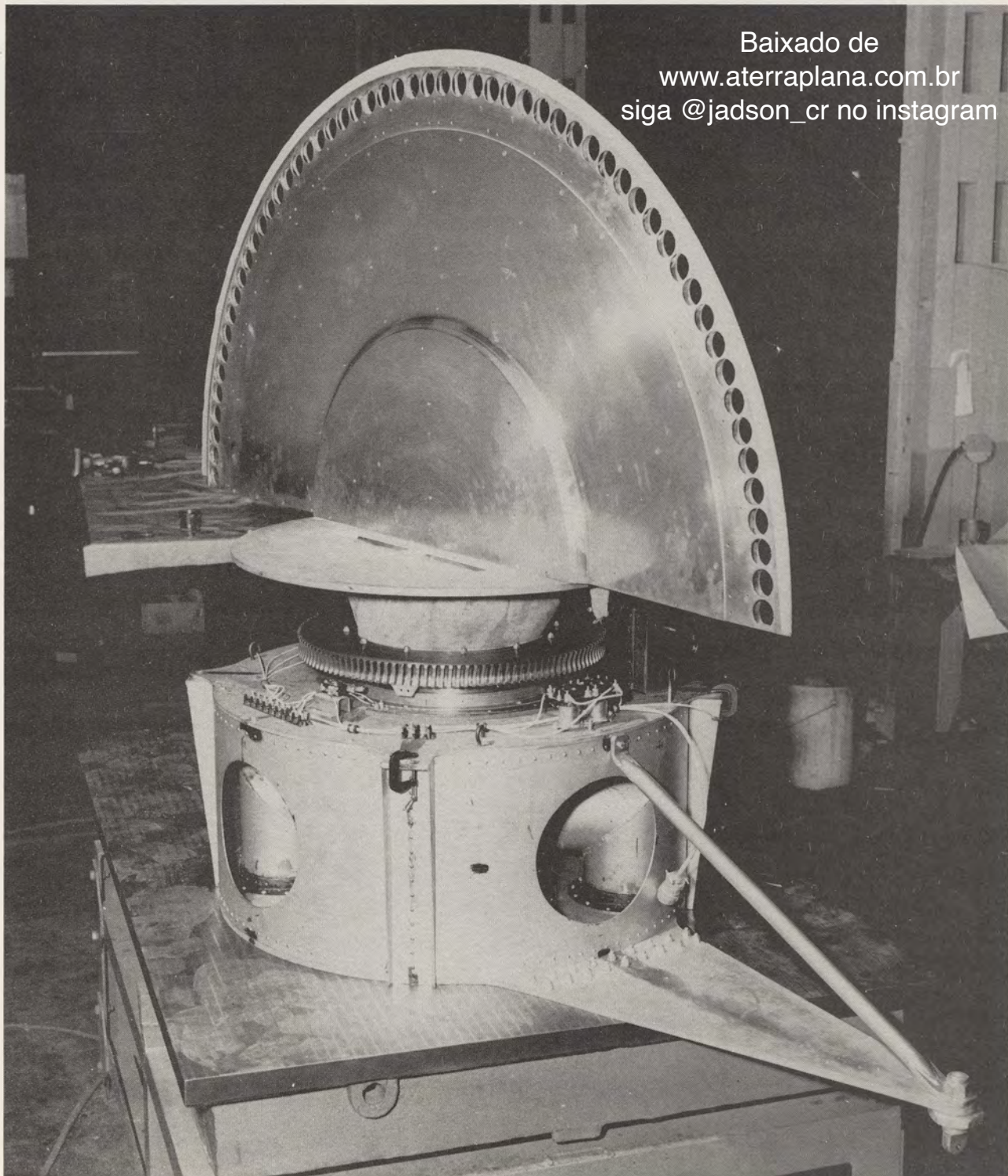
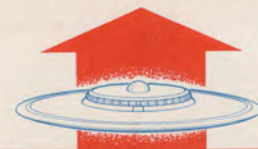
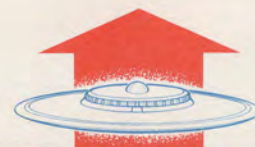


FIG. 13 1/6 SCALE SUBSONIC MODEL



Baixado de
www.aterraplana.com.br
siga @jadson_cr no instagram

FIG. 14



Baixado de
www.aterraplana.com.br
siga @jadson_cr no instagram

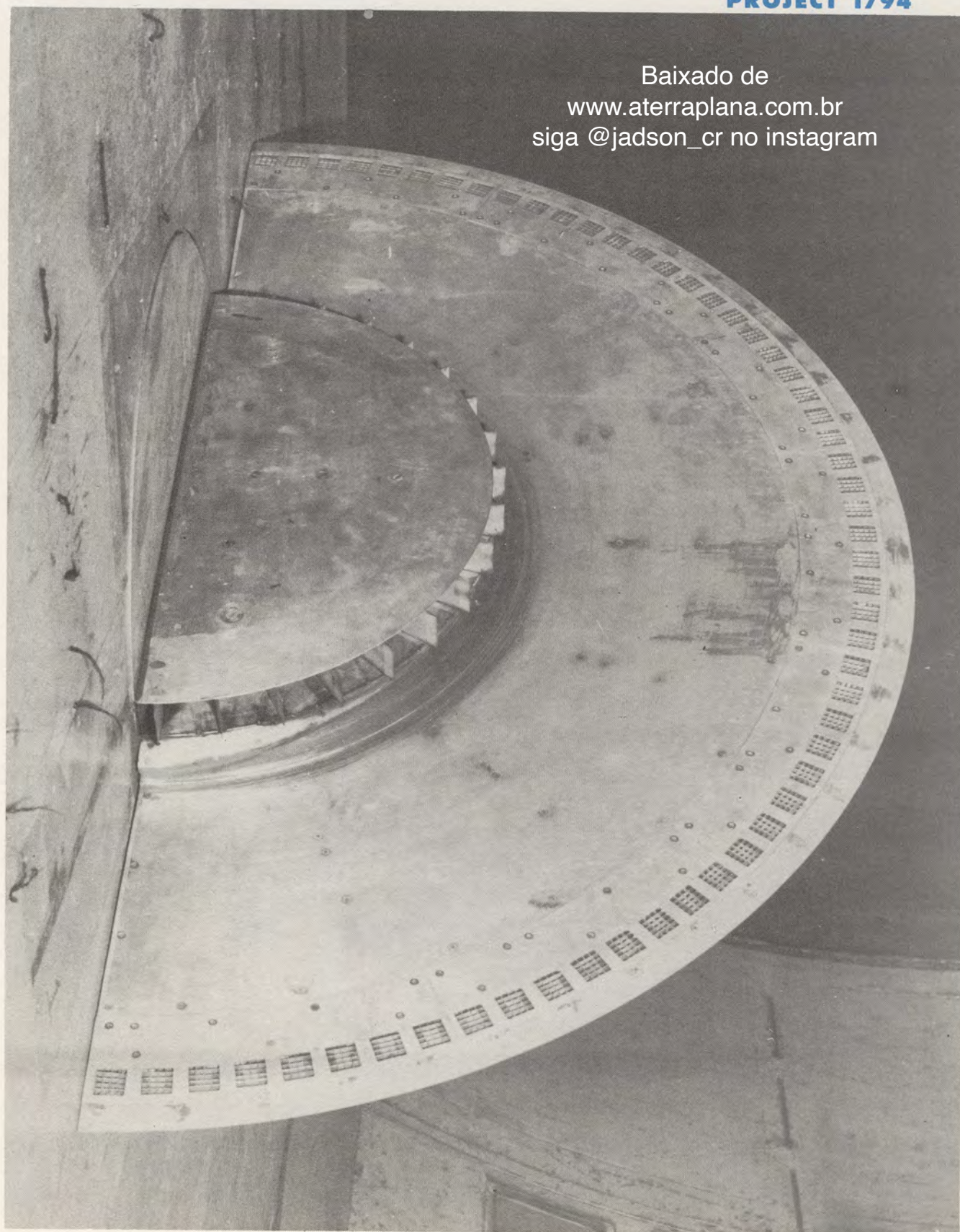
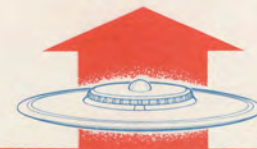


FIG. 15



5.1.1.1
(Cont'd)

Because of the large number of variables - speed, transition control, pitch control, jet thrust, intake flow, ground position and angle of attack - a very complex program was required, which took longer to complete than was anticipated. (Tests were completed June 14). This has caused some delay in the production of final technical reports.

Numerous important details were discovered or verified by these tests. Broad conclusions are as follows:

- (i) The aircraft can be satisfactorily controlled during take-off and landing, through a smooth transition to or from forward flight and at all subsonic speeds; and manoeuvred through a satisfactory subsonic flight envelope. (Fig. 16).
- (ii) It appears that with the thrust less than the weight the aircraft can accelerate and rise smoothly into free air a short distance from the starting point. However, interpretation of the data is difficult since values do not collapse theoretically in the very low speed range and no data was taken very close to zero speed.
- (iii) The aircraft has a high subsonic zero lift drag coefficient and although it has a remarkable lift efficiency (due to the jet effect and negative margin) its subsonic cruising efficiency is poor, as expected. It appears well worth while to reduce subsonic drag in order to improve acceleration, and subsonic endurance. (Fig. 17).

Further tests with this model are required.

- (i) To obtain transition data down to very low speed. Even low

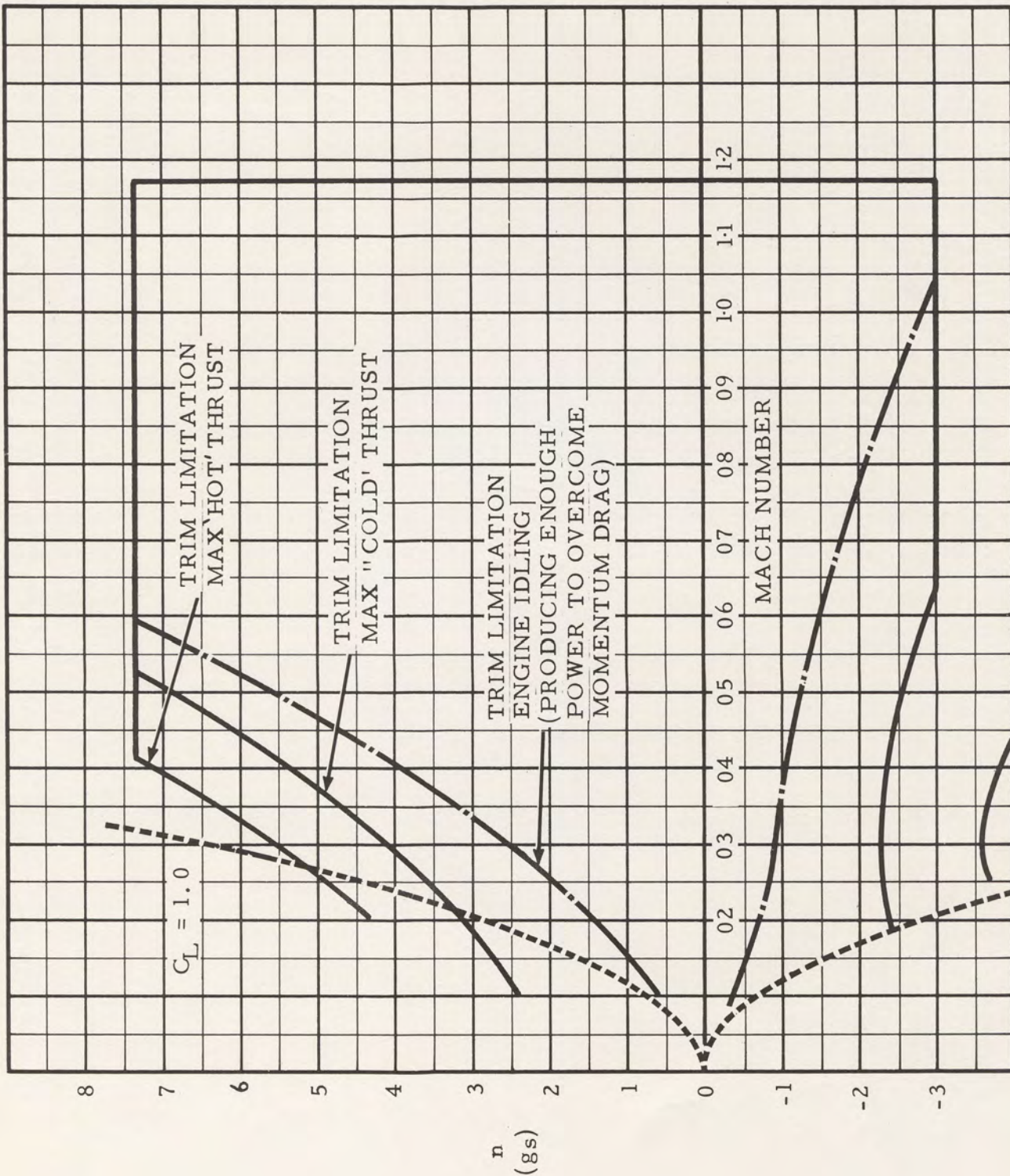


FIG. 16 PROJECT 1794 FLIGHT ENVELOPE S. L.
 AIRCRAFT WEIGHT = 20000 LB

~~SECRET~~

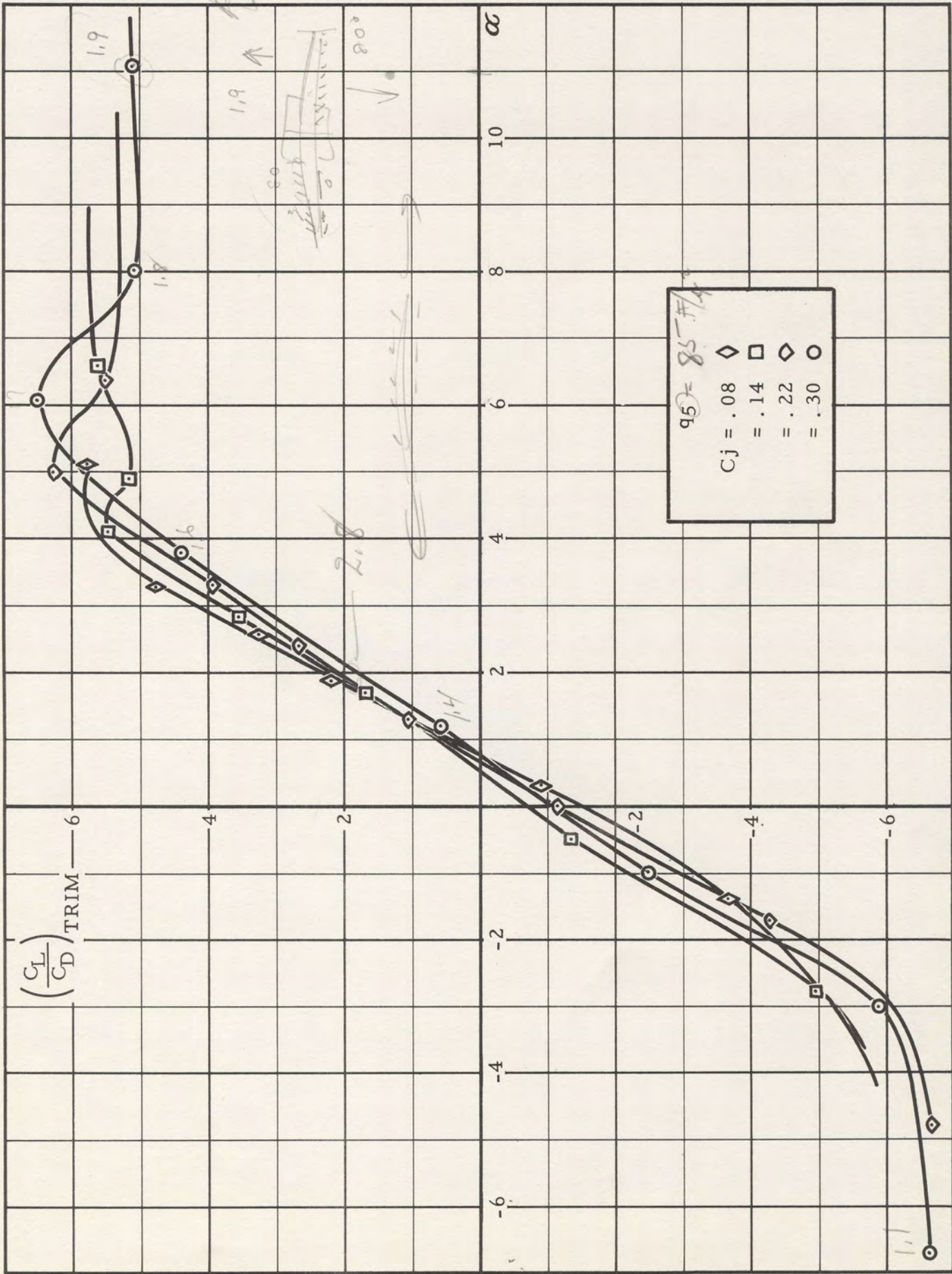


Fig. 17

~~SECRET~~

5.1.1.1
(Cont'd)

accuracy data would be regarded as valuable confirmation of the transition flight path.

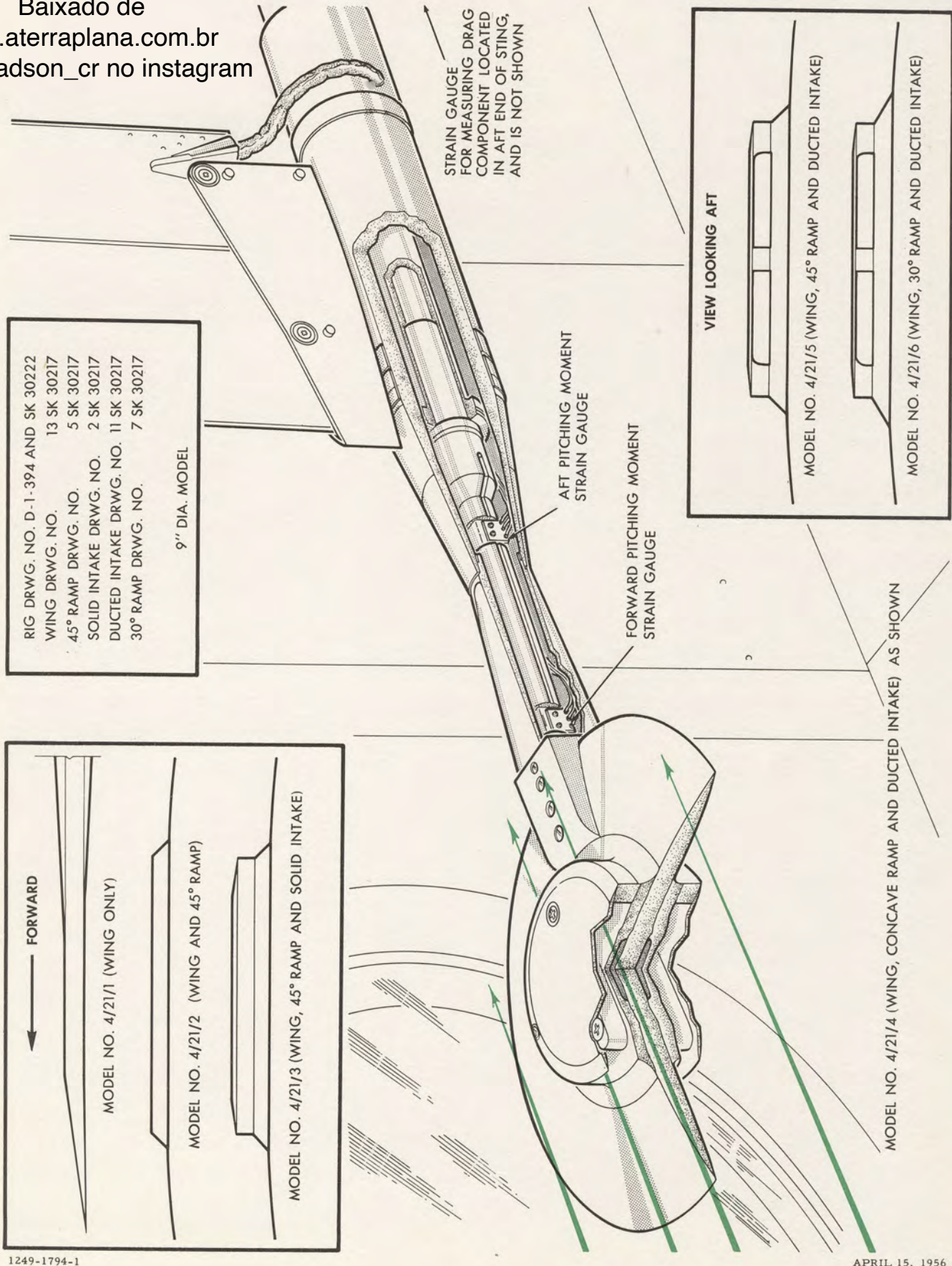
- (ii) To investigate the surface pressure distribution on the aircraft in various flight conditions.
- (iii) To investigate control scheme modification to improve transition control characteristics through the whole angle of attack-ground distance range, and to improve subsonic cruising efficiency.
- (iv) To check the effect of simulating the exhaust with a hot jet on the drag and the aerodynamic characteristics, (originally planned, but postponed).
- (v) To investigate reducing the subsonic drag by intake modification.

5.1.1.2 Three supersonic models have been tested involving 76 hours test time and eight days tunnel occupancy. These tests were done in the Massachusetts Institute of Technology Naval Supersonic Laboratory 18" x 24" section supersonic tunnel. These models were:

- (i) A sting mounted 1/40 scale* model built up by components, with no flow simulation. (Figs. 18 and 19).
- (ii) A 1/23 scale* reflection plane force model, with air intake, jet flow and control position simulation. (Figs. 20 and 21).

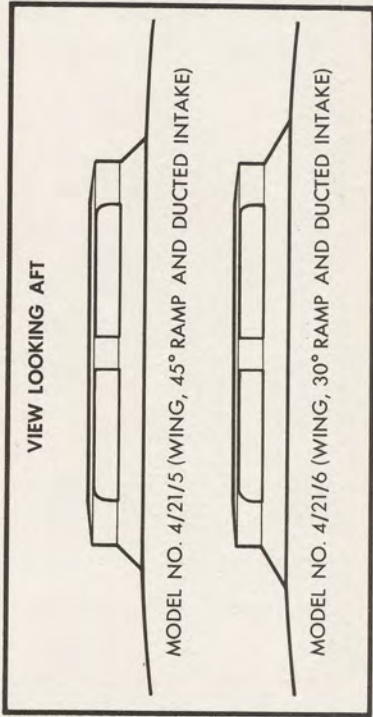
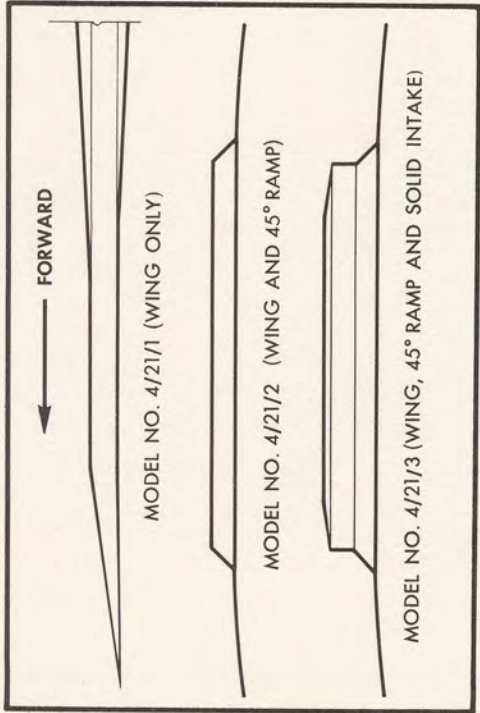
* See footnote at bottom of page 20.

Baixado de
www.ateraplana.com.br
siga @jadson_cr no instagram



RIG DRWG. NO. D-1-394 AND SK 30222
 WING DRWG. NO. 13 SK 30217
 45° RAMP DRWG. NO. 5 SK 30217
 SOLID INTAKE DRWG. NO. 2 SK 30217
 DUCTED INTAKE DRWG. NO. 11 SK 30217
 30° RAMP DRWG. NO. 7 SK 30217

9" DIA. MODEL

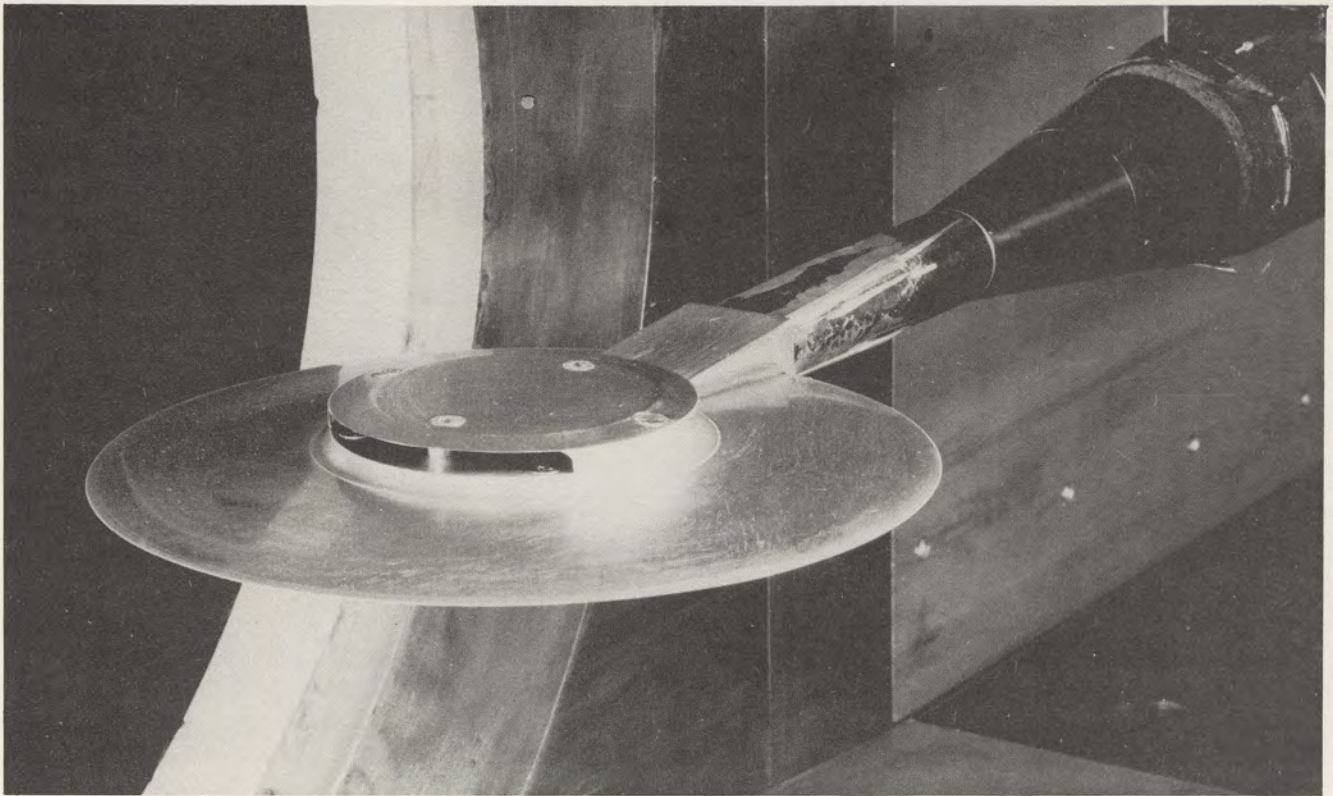


MODEL NO. 4/21/4 (WING, CONCAVE RAMP AND DUCTED INTAKE) AS SHOWN

1249-1794-1

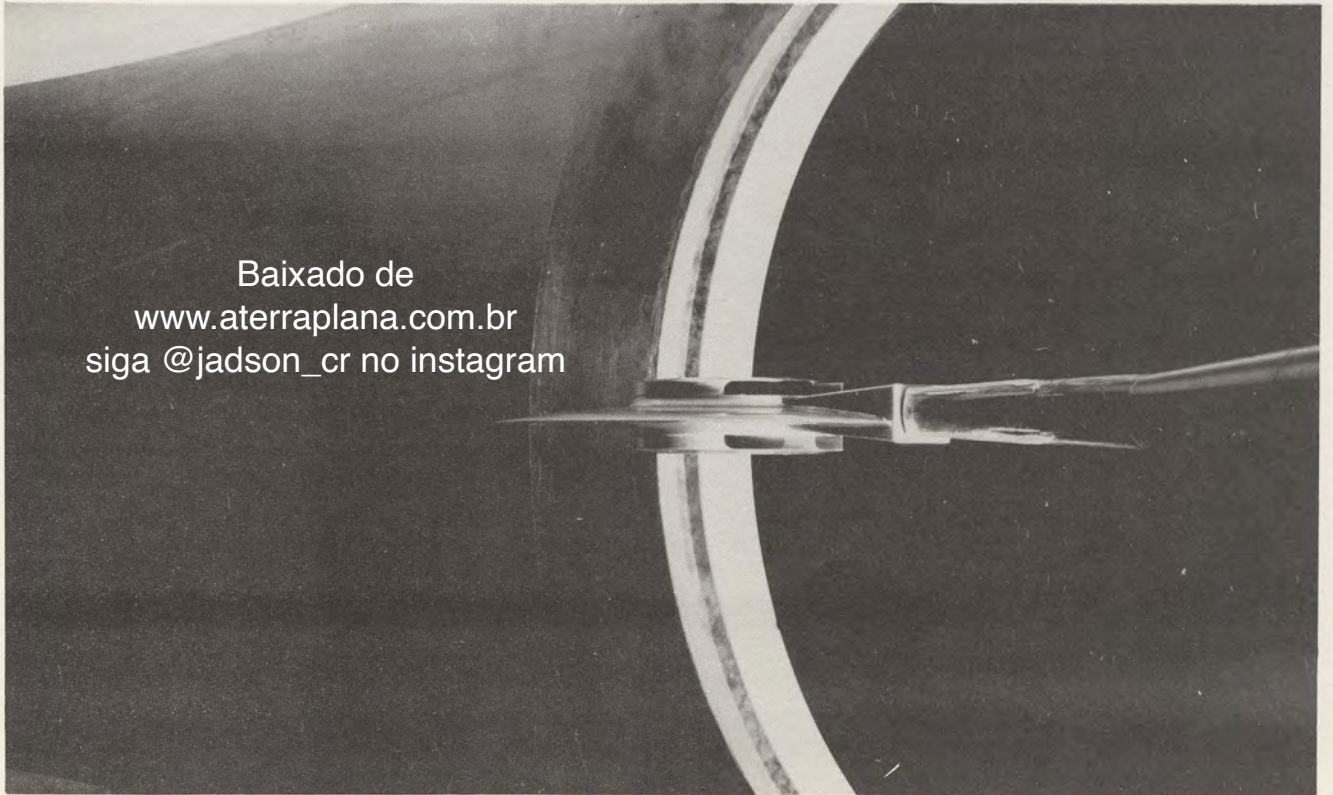
APRIL 15, 1956

FIG. 19 PERFORMANCE MODEL NO. 4/21



FORWARD UPPER SURFACE OF THE $WR_{C_I D}$ CONFIGURATION
AS INSTALLED IN THE M. I. T. - N. S. L. SUPERSONIC WIND TUNNEL

1540-1794-1



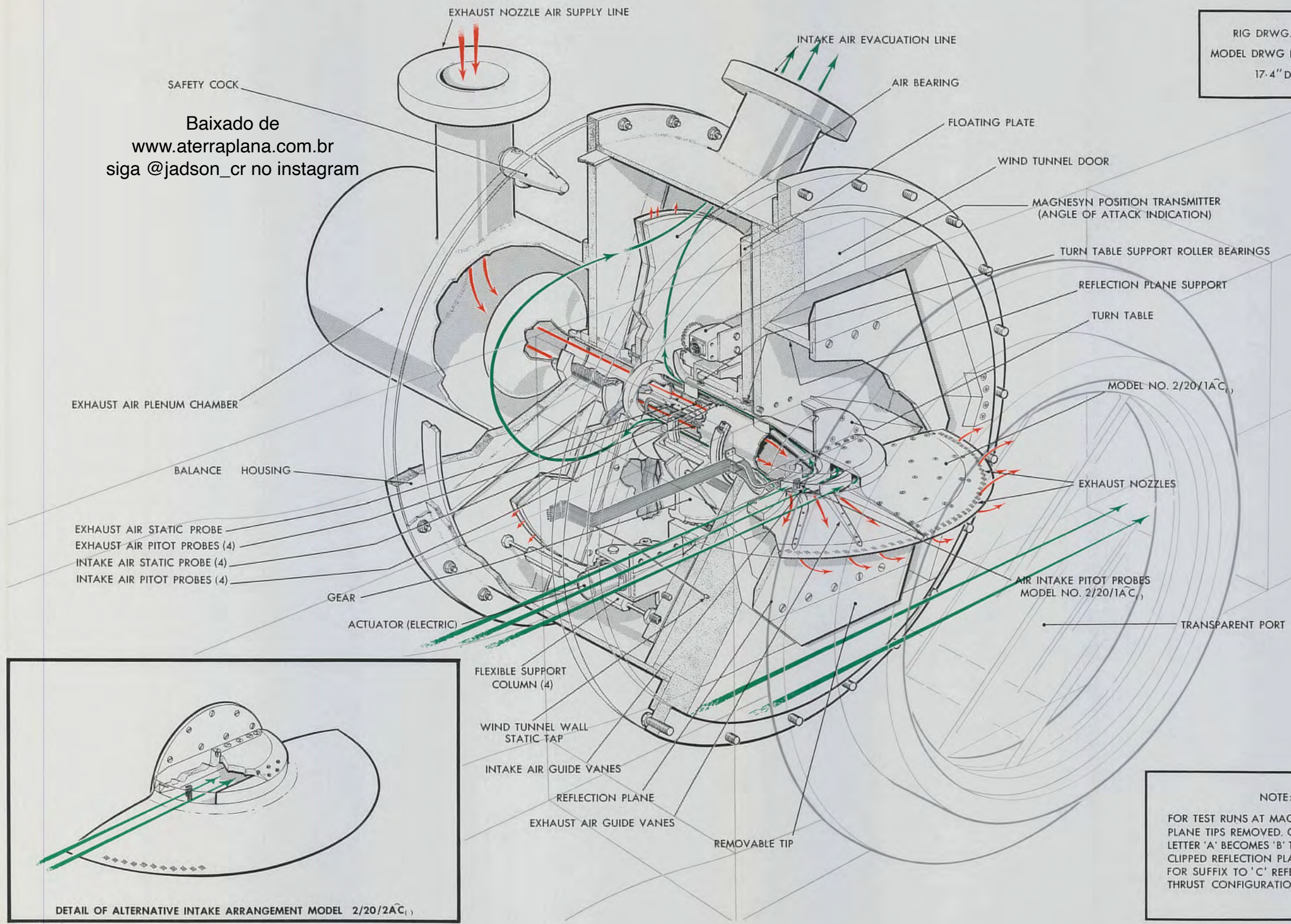
Baixado de
www.aterraplana.com.br
siga @jadson_cr no instagram

FIG. 18 REAR VIEW OF THE $WR_{C_I D}$ CONFIGURATION AS INSTALLED
IN THE M. I. T. - N. S. L. SUPERSONIC WIND TUNNEL

~~SECRET~~

RIG DRWG. NO. SK30213
MODEL DRWG NO. SK30195 SHT.5
17.4" DIA. MODEL

Baixado de
www.aterraplana.com.br
siga @jadson_cr no instagram



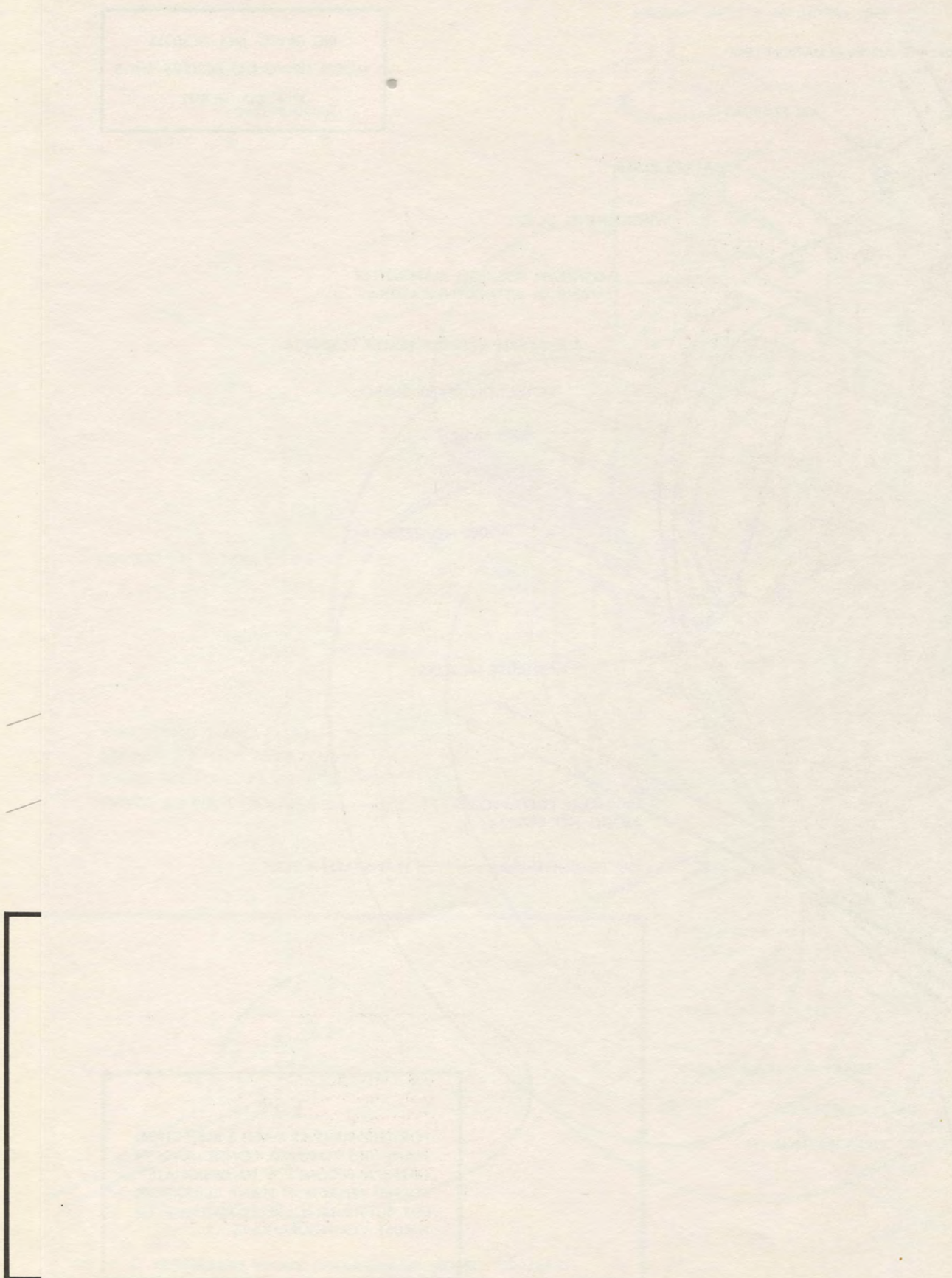
NOTE:
FOR TEST RUNS AT MACH 3 REFLECTION PLANE TIPS REMOVED. CONFIGURATION LETTER 'A' BECOMES 'B' TO DESIGNATE CLIPPED REFLECTION PLANE CONDITION. FOR SUFFIX TO 'C' REFER TO TABLE OF THRUST CONFIGURATIONS.

1244-1794-1

MAY 23, 1956

STABILITY AND CONTROL MODEL NO 2/20

~~SECRET~~



1244-

FIG. 20
STABILITY AND CONTROL MODEL NO. 2/20

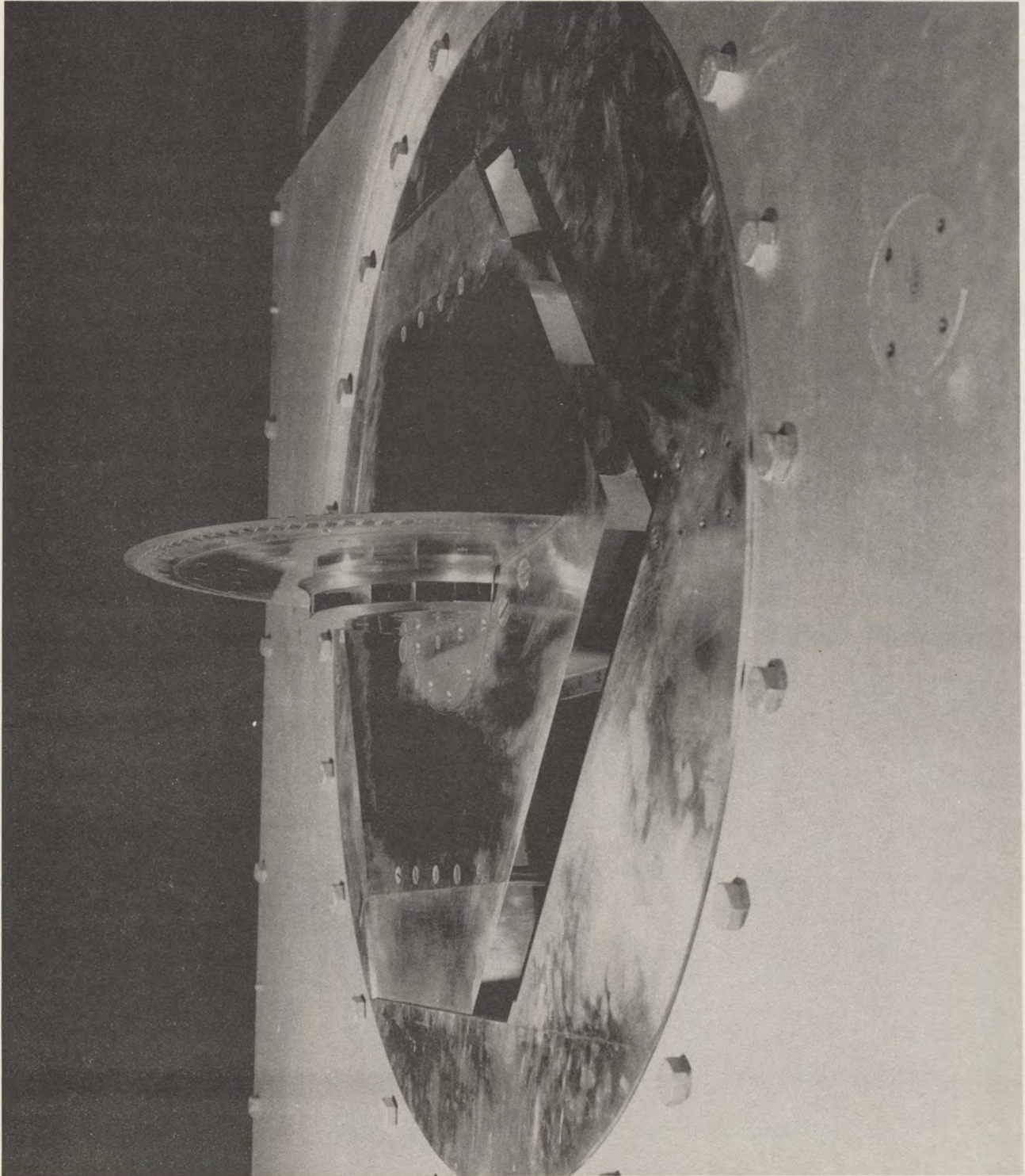


FIG. 21 SUPERSONIC FORCE MODEL

5.1.1.2
(Cont'd)

- (iii) A 2/25 scale* air intake pressure recovery model. Figs. 22 - 23).

Broad conclusions from these tests are as follows:

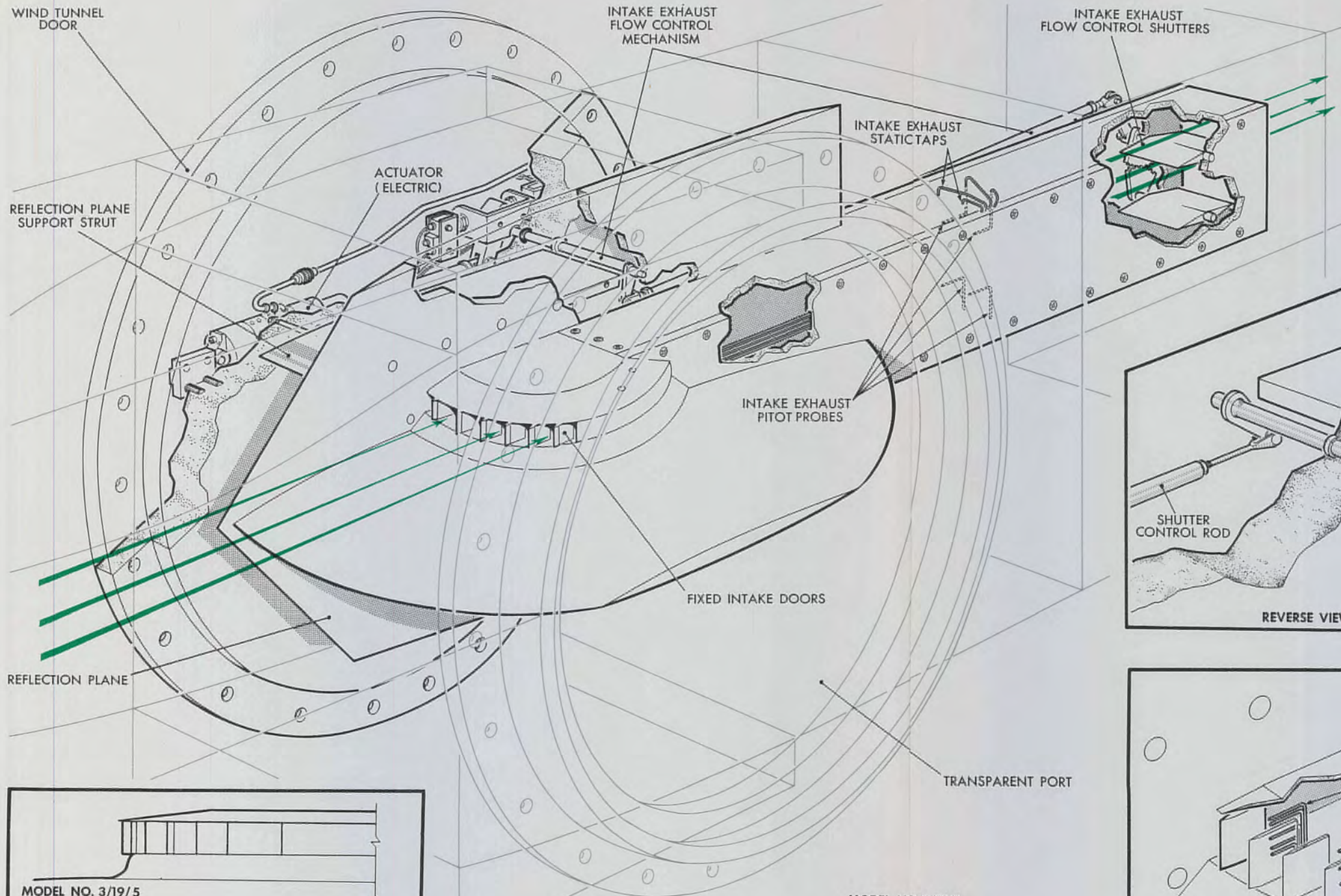
- (i) The aircraft can be satisfactorily controlled and manoeuvred from engine idling to maximum thrust at supersonic speed through a satisfactory supersonic flight envelope. (Figs. 24 and 25).
- (ii) The drag of the aircraft agrees quite closely with the estimate. (Fig 26).
- (iii) The supersonic cruising efficiency appears to be better than had been expected. (Fig. 27).
- (iv) The air intake pressure recovery is better than the estimate. (Fig. 28).

Further tests with these models are seen to be required:

- (i) To obtain further confirmation of the aircraft drag with the air intake running full. (The evacuation system failed to operate to the planned capacity during the tests).
- (ii) To generally extend the scope of the data. Due to the restricted testing time a too abbreviated program had to be accepted.
- (iii) To carry out transonic tests on the sting mounted model. (Planned but not achieved due to detail test difficulties).

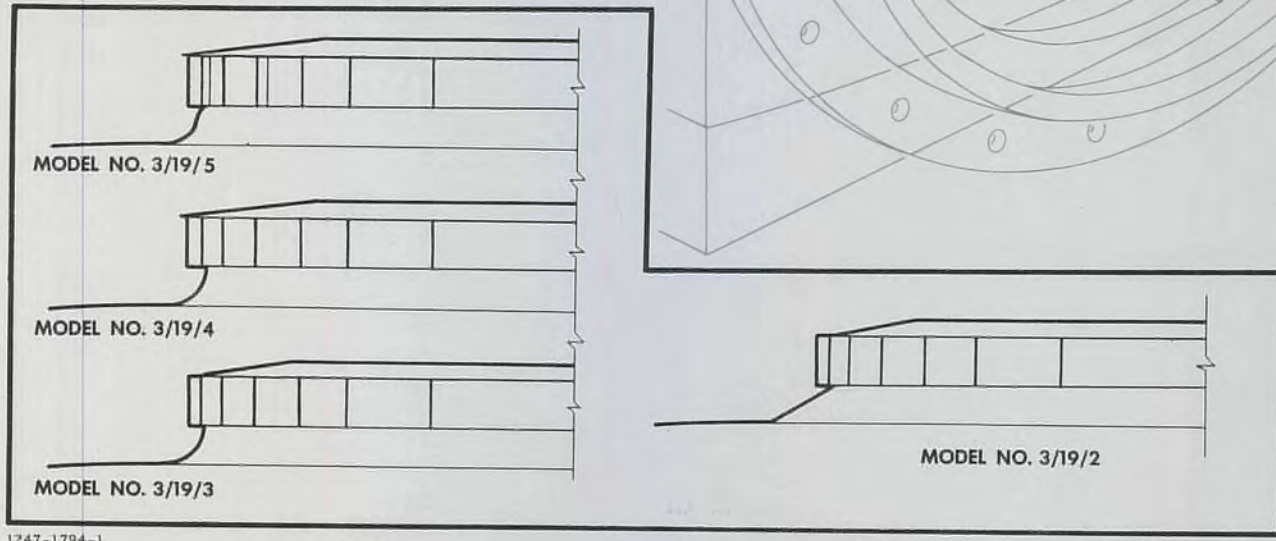
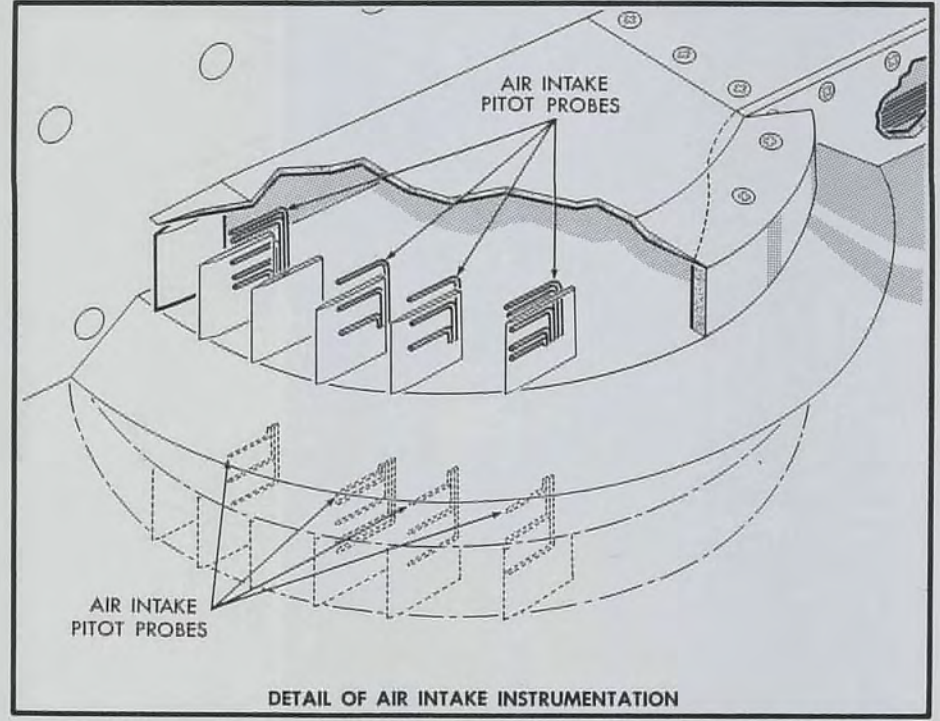
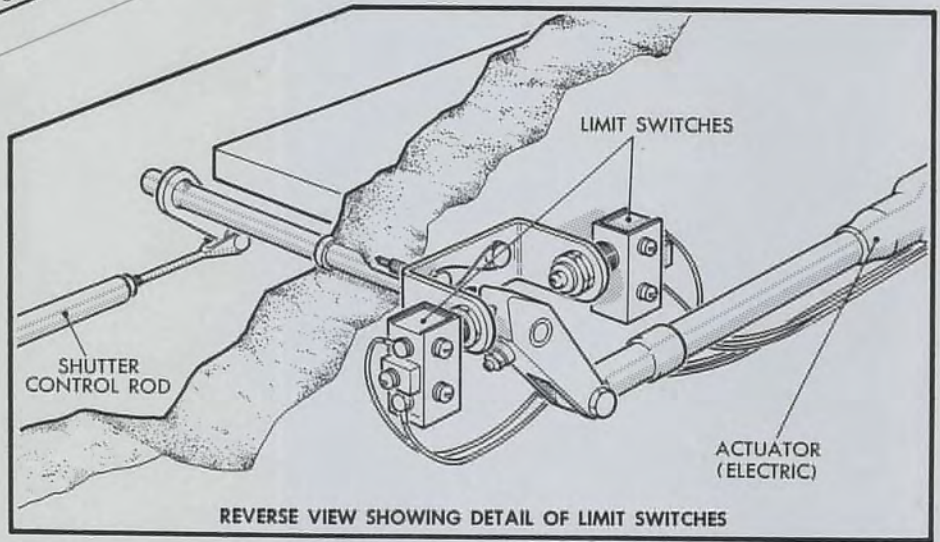
* See footnote at bottom of page 20.

~~SECRET~~



MODEL DRWG NO. SK30212 SHT. 1

EXTENDED ROOF	110 & 111 SK 30212
CONCAVE & CONVEX RAMP	107 & 108 SK 30212
EXTENDED ROOF	10 & 11 SK 30212
CONCAVE RAMP	13 & 14 SK 30212
NORMAL ROOF	3 & 4 SK 30212
45° RAMP	15 & 16 SK 30212
30° RAMP	17 & 18 SK 30212
32" DIA. MODEL	



1247-1794-1

APRIL 25, 1956

AIR INTAKE AND GAS EXHAUST SYSTEM MODEL NO. 3/19

~~SECRET~~

WIND
C

REFLE
SUPI

REFLE

MC

MC

MC

1247-1

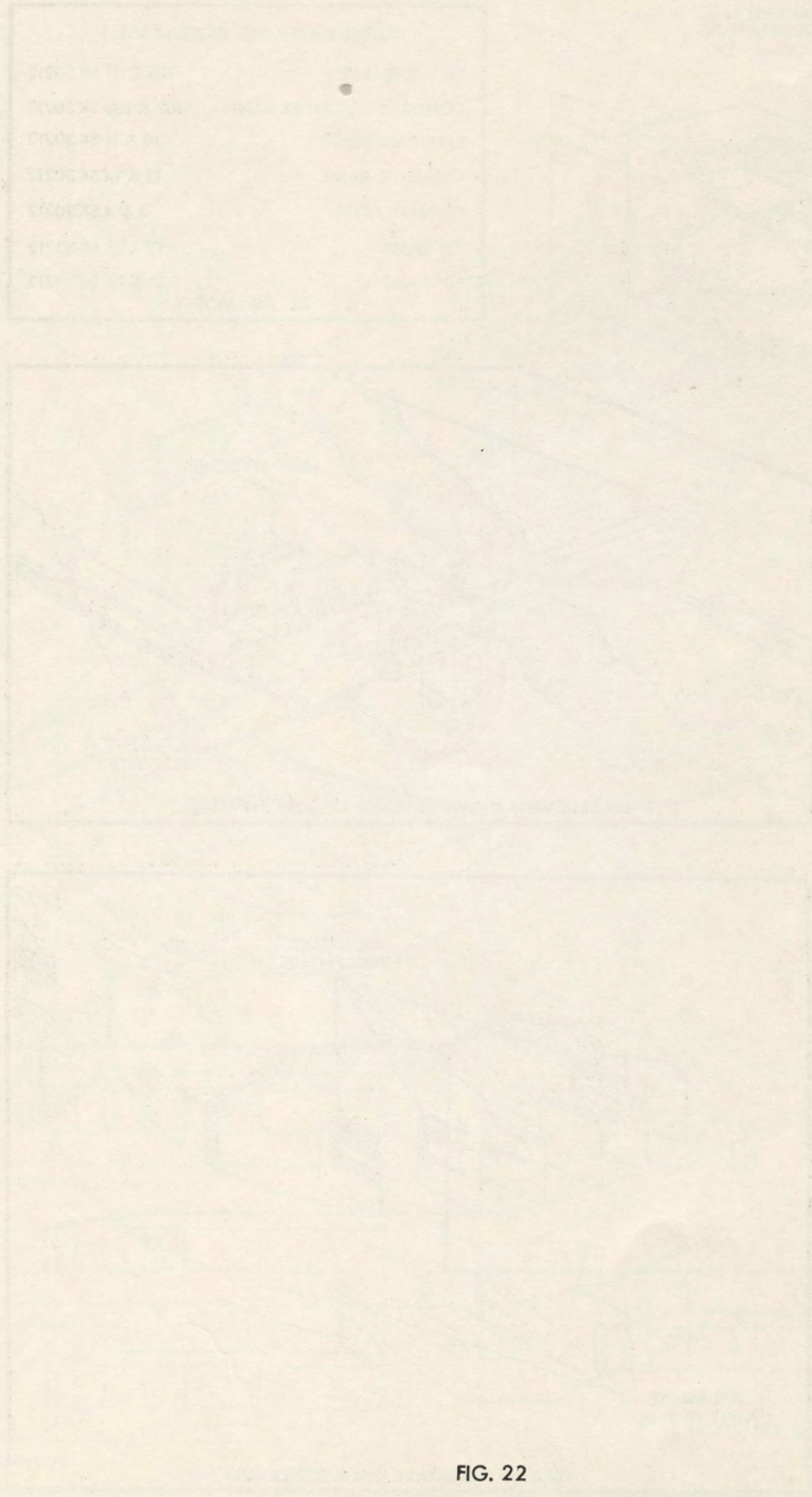


FIG. 22

AIR INTAKE AND GAS EXHAUST SYSTEM MODEL NO. 3/19

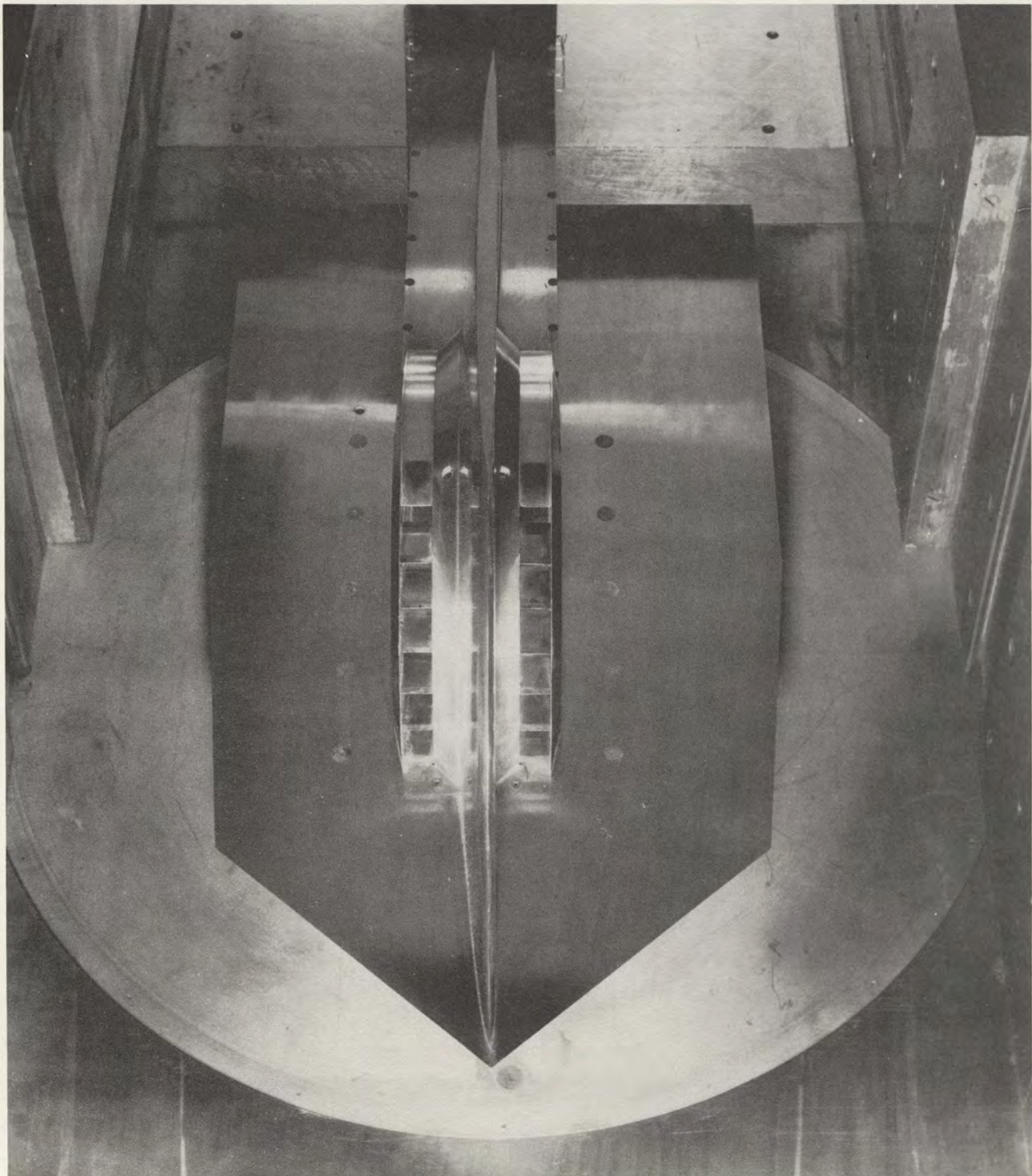


FIG. 23 SUPERSONIC AIR INTAKE MODEL INSTALLED

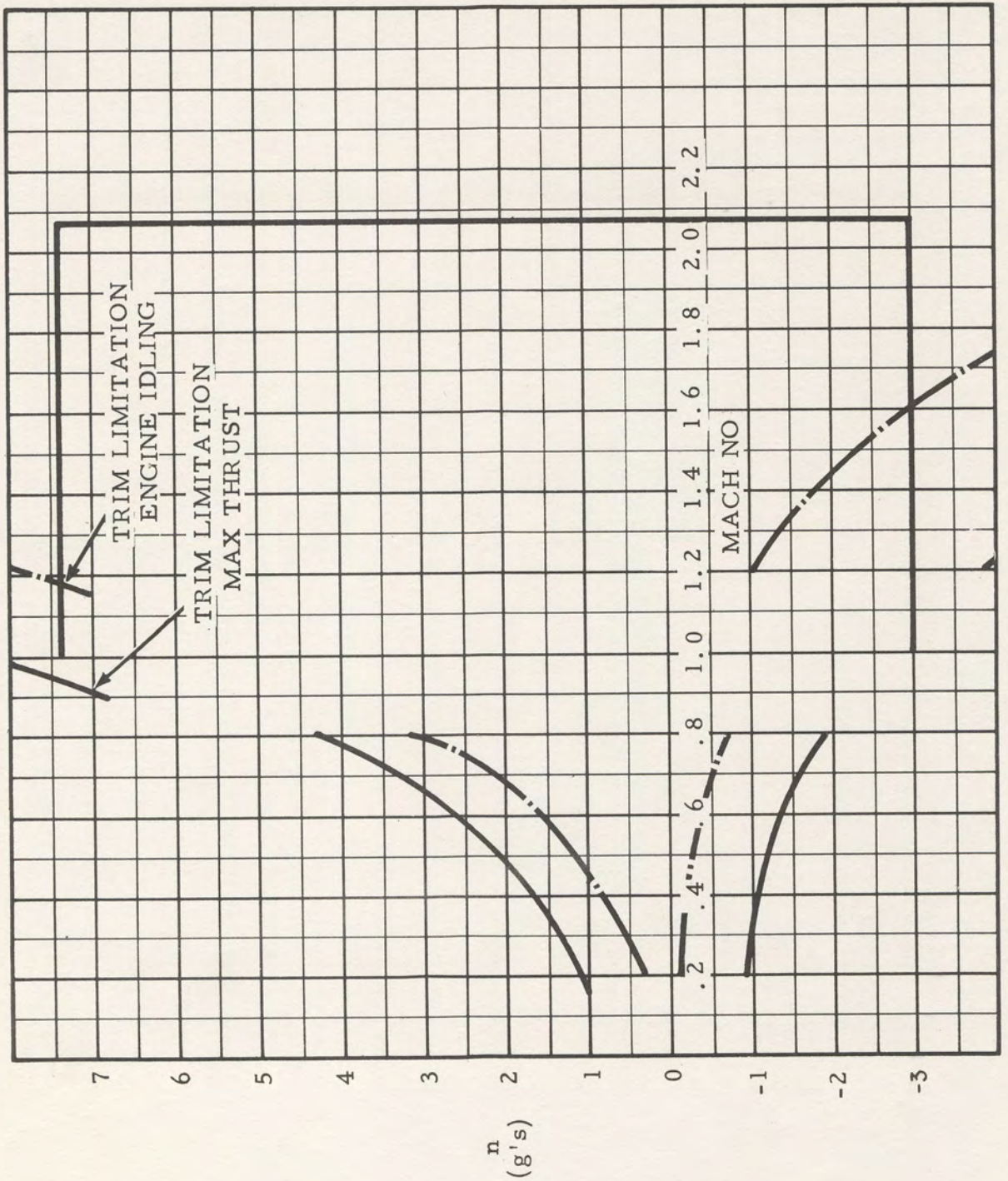


FIG. 24 PROJECT 1794 FLIGHT ENVELOPE 40000' W = 20000 LB

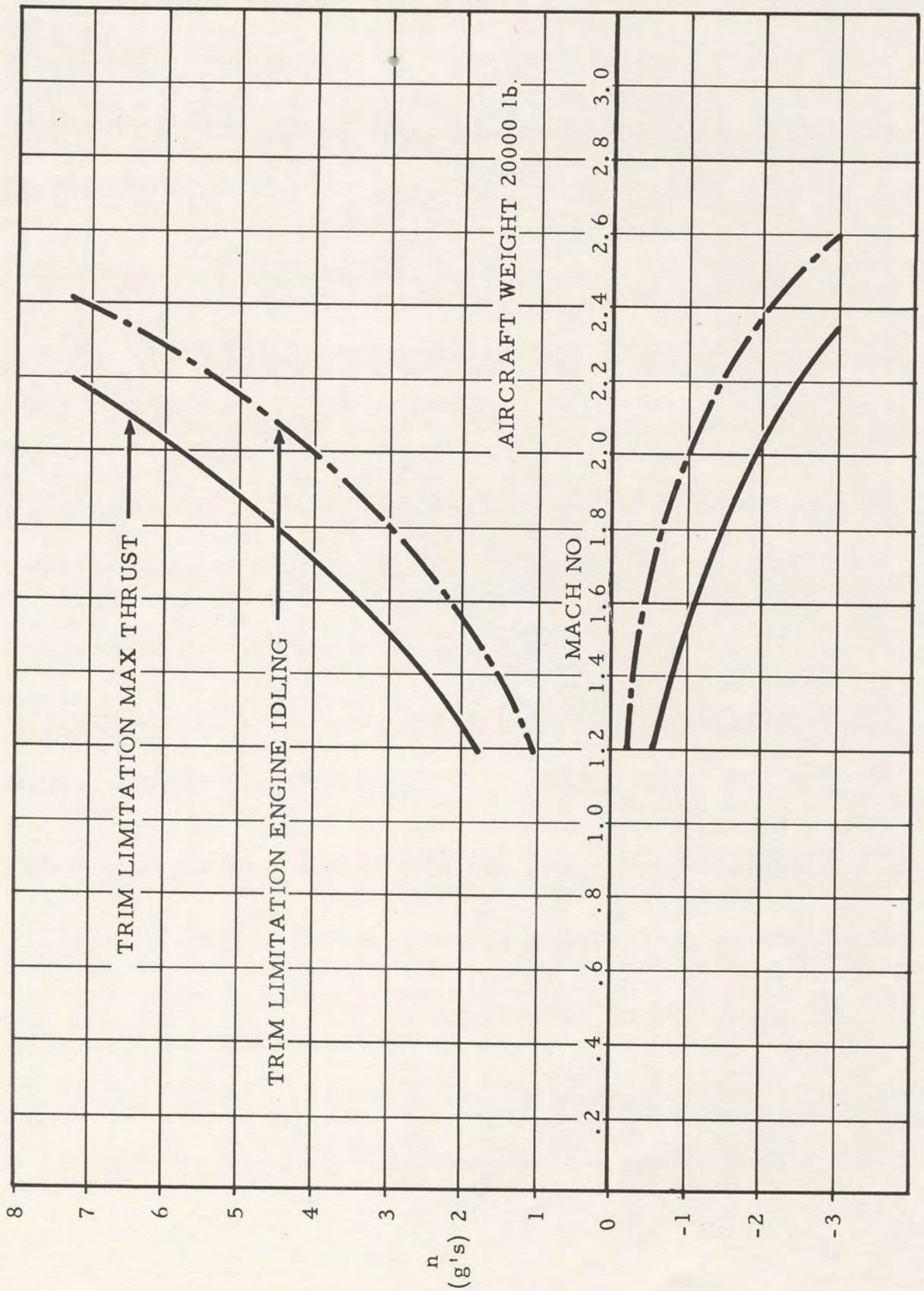
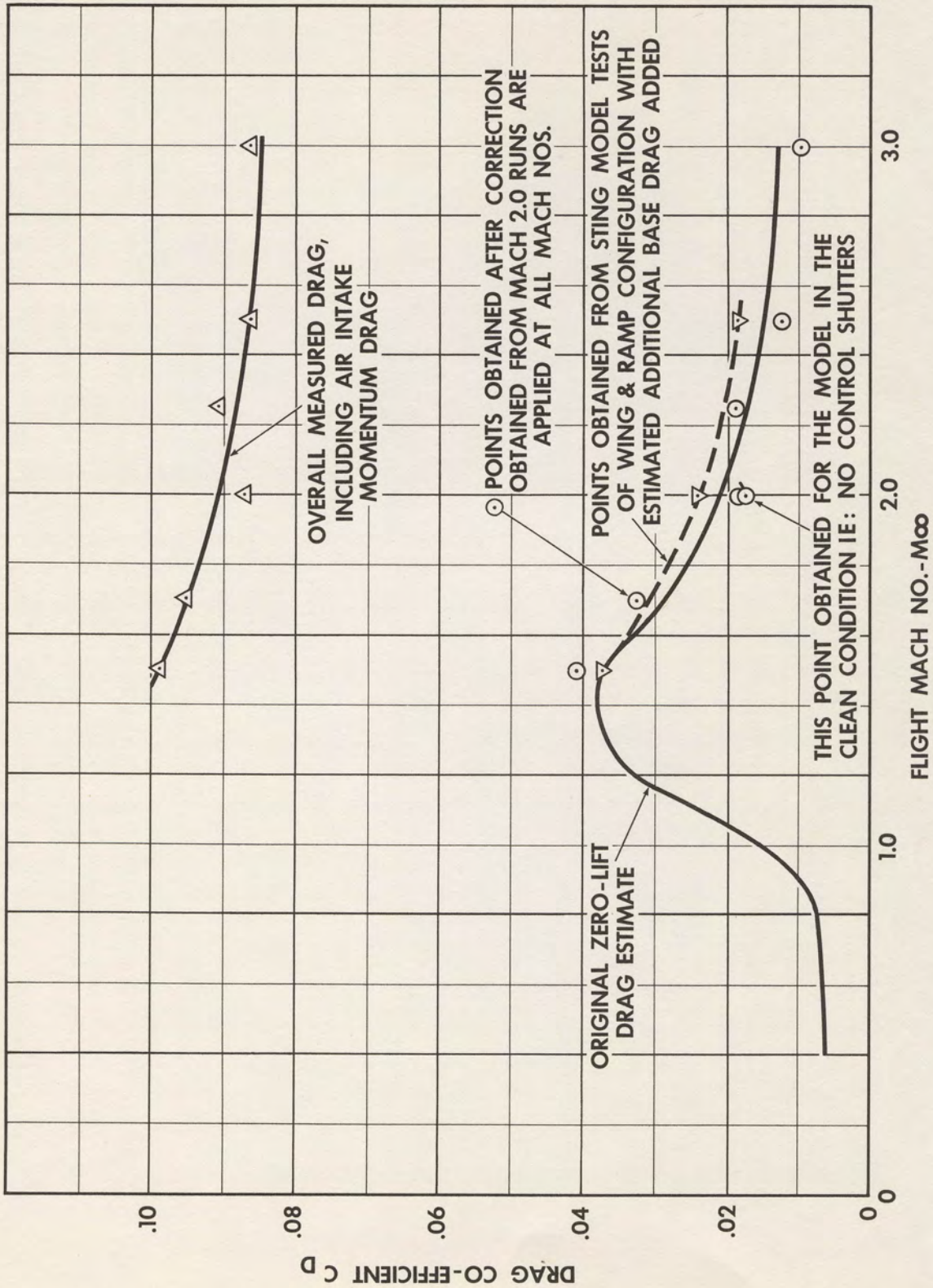
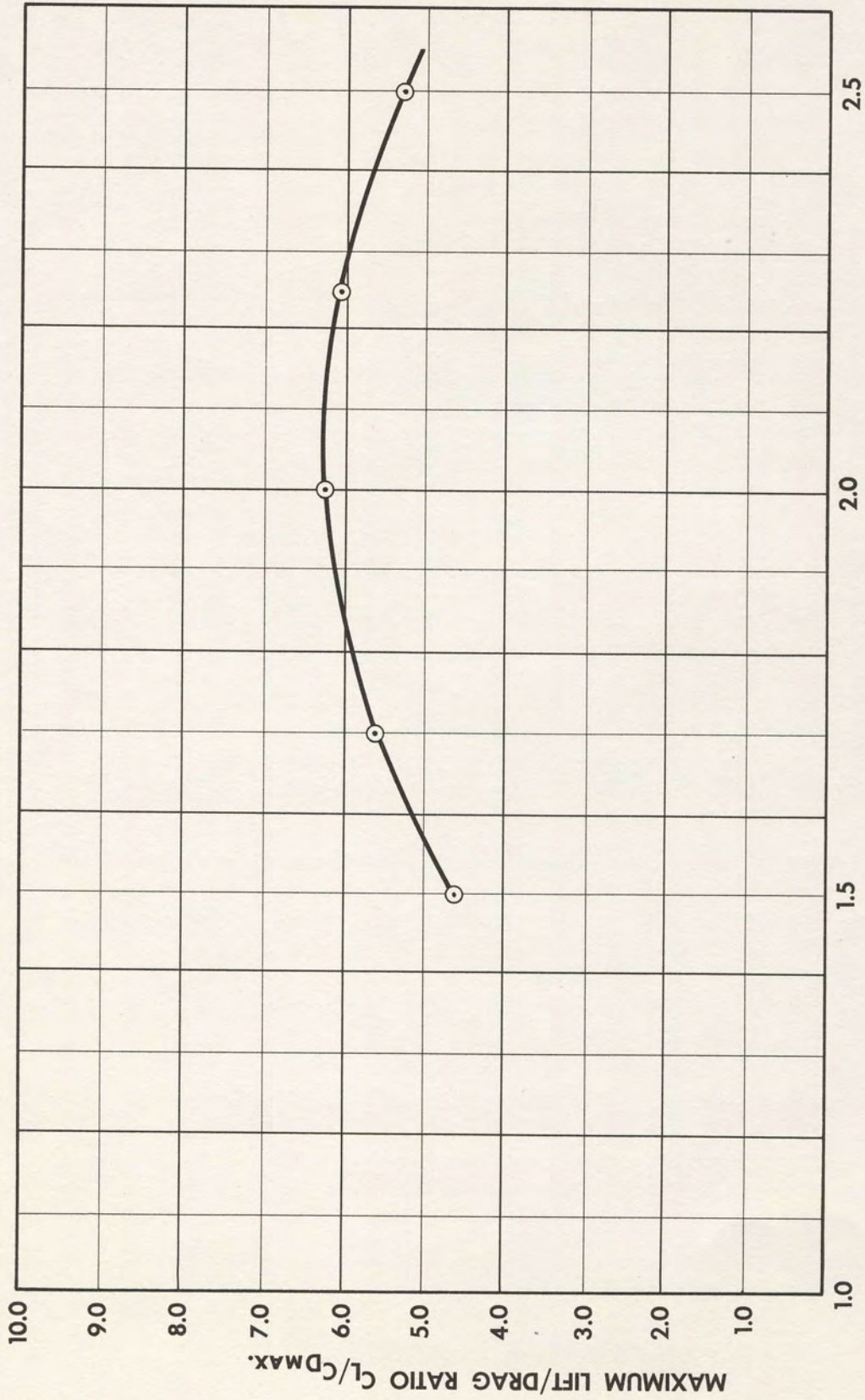


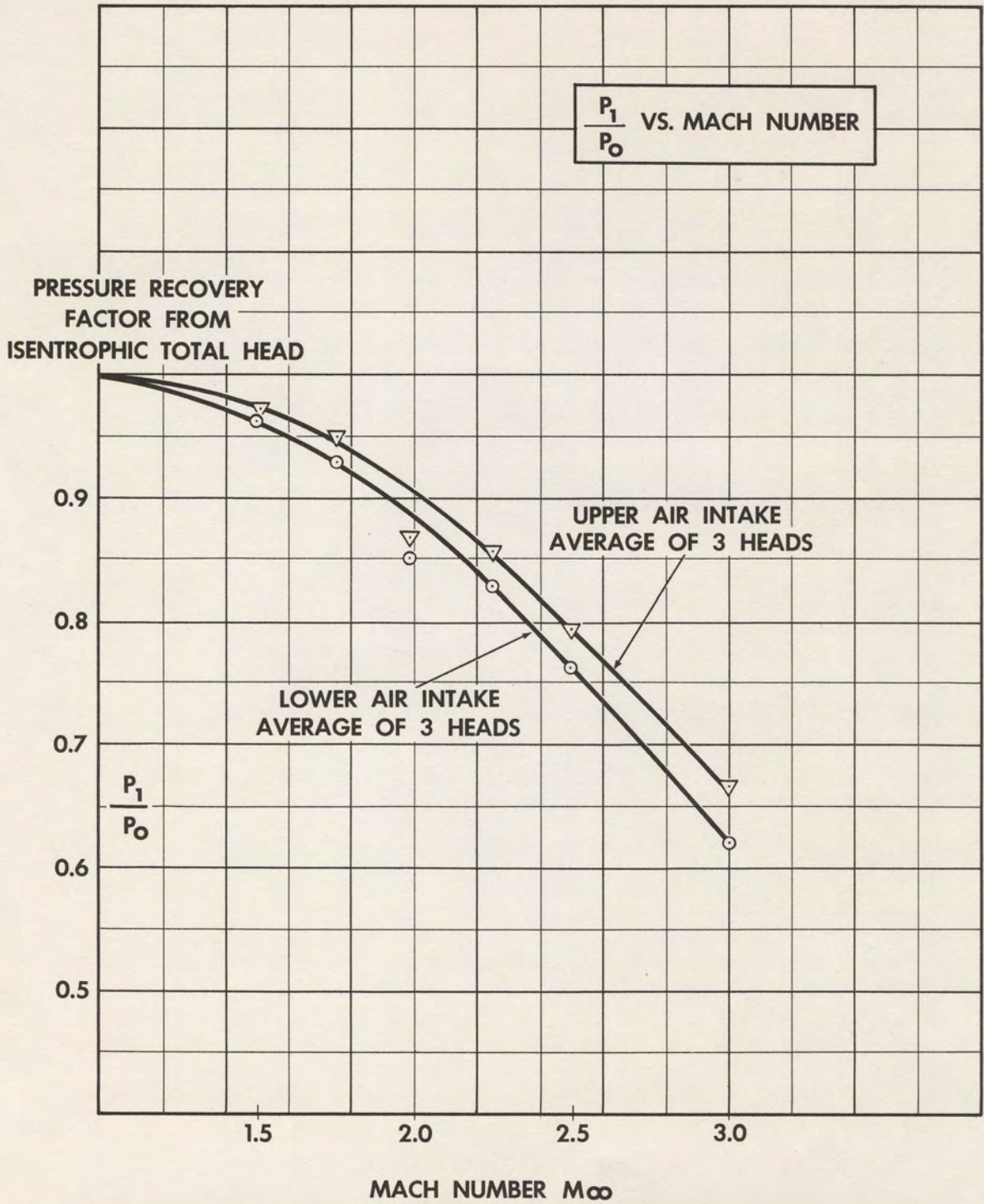
FIG 25 PROJECT 1794 FLIGHT ENVELOPE 80,000



PROJECT 1794 ZERO LIFT DRAG AND MACH NO.
FIG. 26



PROJECT 1794 VARIATION OF MAXIMUM LIFT / DRAG RATIO WITH MACH NUMBER
FIG. 27



PROJECT 1794 INTAKE PRESSURE RECOVERY
FIG. 28

1533-704-1

5.1.1.2
(Cont'd)

(iv) To develop the air intake boundary layer bleeding system.

This is a simple cusp below the air entry; several shapes were tested with indication that considerable further improvement is possible.

5.1.1.3 A number of small scale tests was carried out in the contractor's 18" x 18" low subsonic and 8" x 11" supersonic open circuit tunnel (Figs. 29 and 30) as follows:

Preliminary subsonic transition characteristics (Fig. 31)

Preliminary subsonic jet-trim characteristics (Figs. 32, 33 and 34)

Preliminary supersonic jet-trim characteristics (Fig. 35)

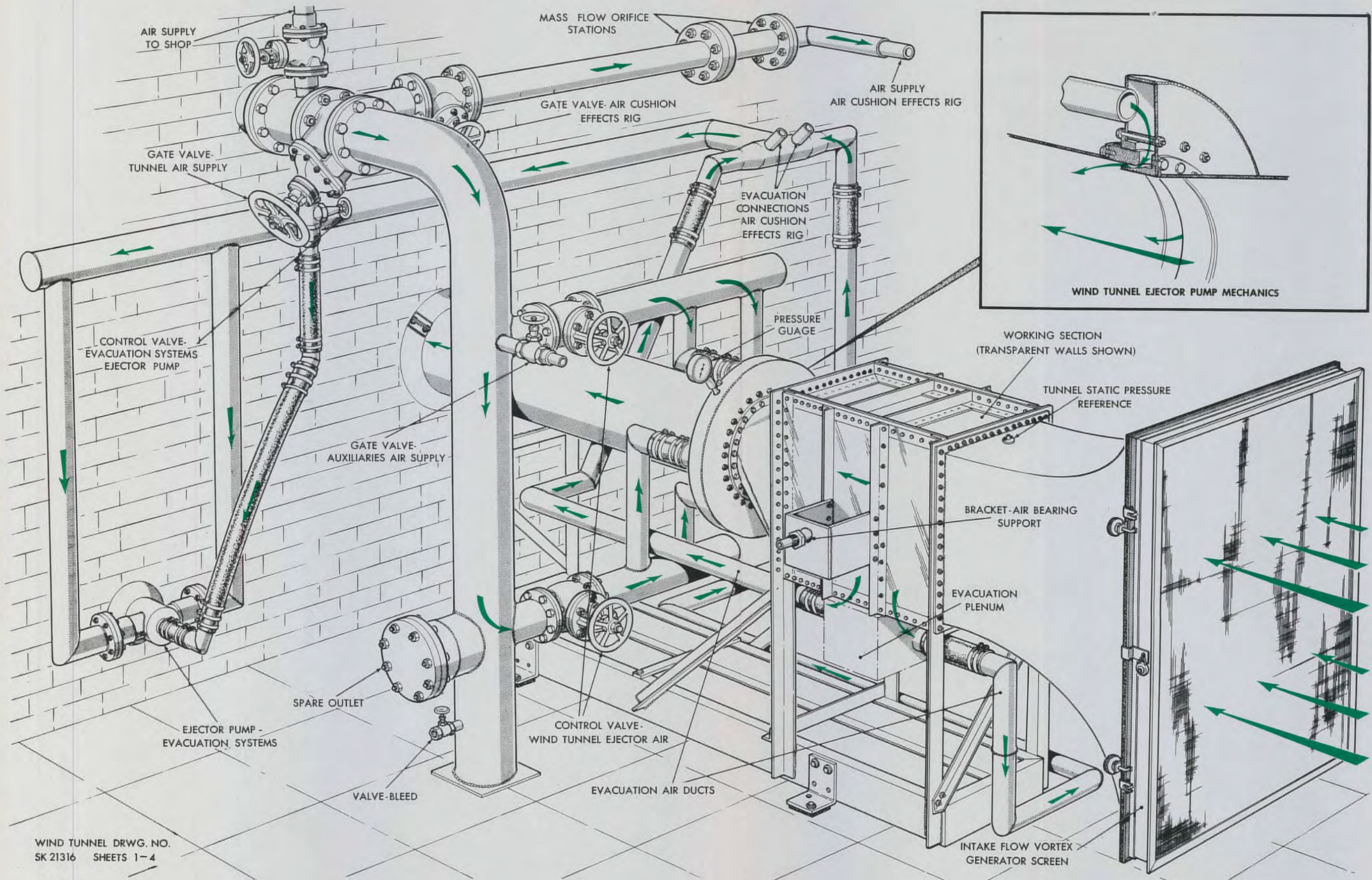
Dynamic behaviour of rate and displacement stability models (Figs. 36 and 37)

Air intake internal flow model (Fig. 38 and 39)

The preliminary tests were carried out on both half-plane and full models. The results were such as to justify the larger scale program which was then embarked upon, and no important conclusions not validated by the main program can be drawn. These tests have therefore not been reported in detail. Illustrations of the models appear in Figs. 31 through 39, as noted above.

Numerous further preliminary and ad hoc tests on other small models will almost certainly be required as design and development proceeds.

SECRET

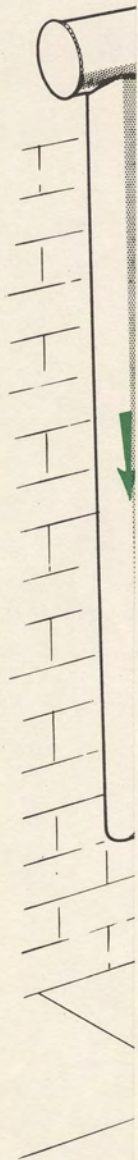


WIND TUNNEL DRWG. NO.
SK 21316 SHEETS 1-4

1349-1794-2

AVRO EJECTOR WIND TUNNEL- (SUBSONIC INSTALLATION SHOWN)

SECRET



WIND
SK 213

1349-17

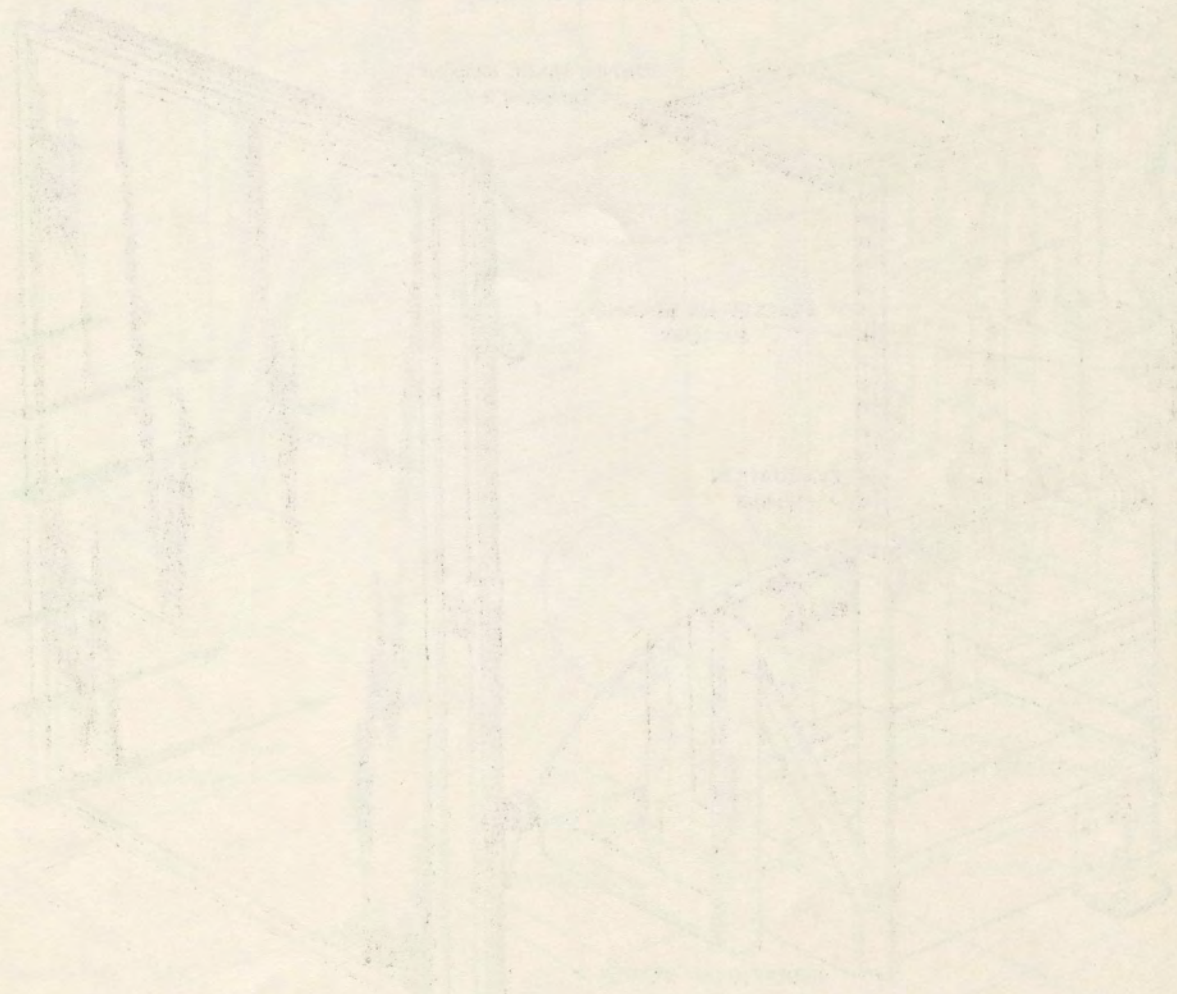
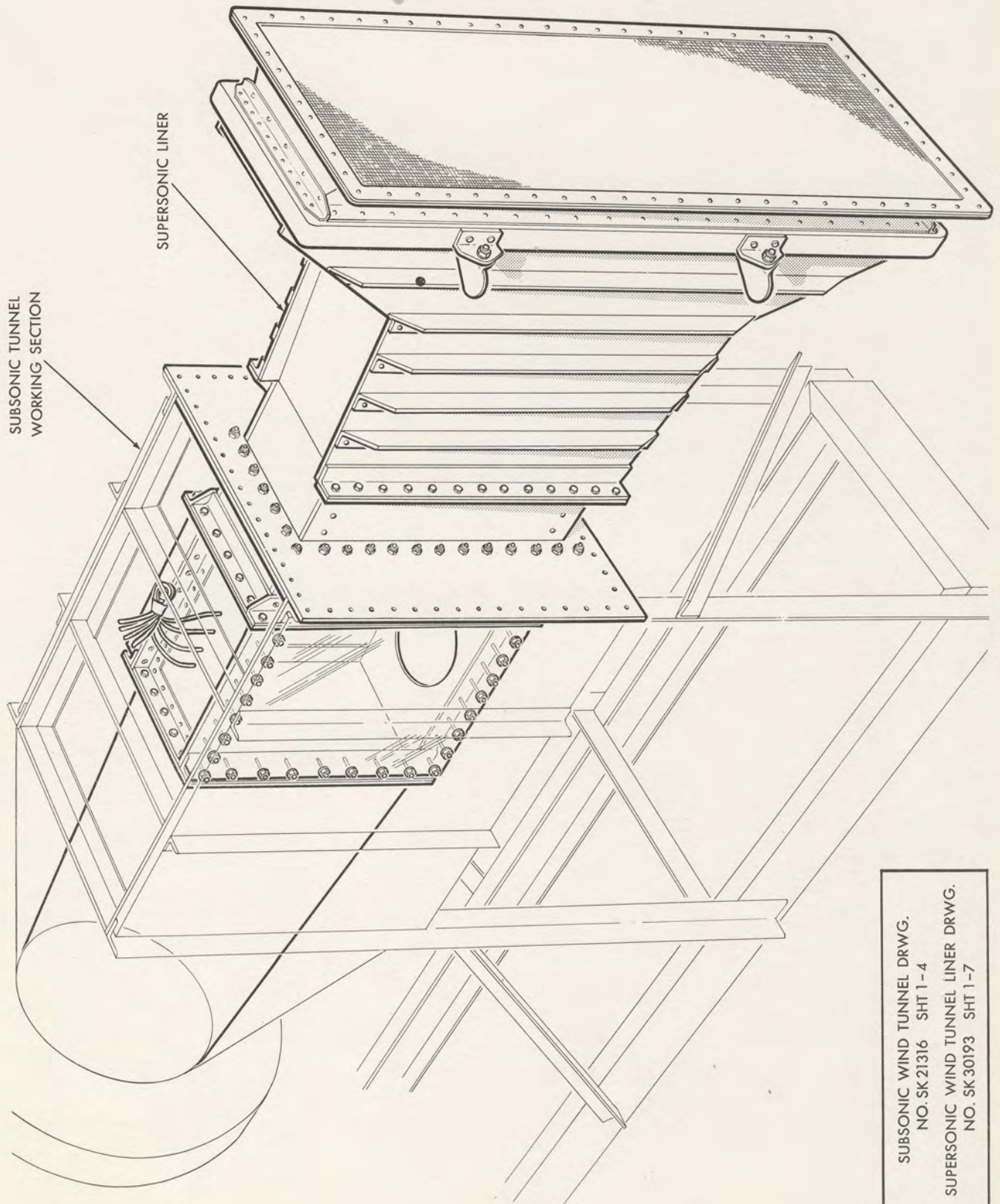


FIG. 29

AVRO EJECTOR WIND TUNNEL - (SUBSONIC INSTALLATION SHOWN)

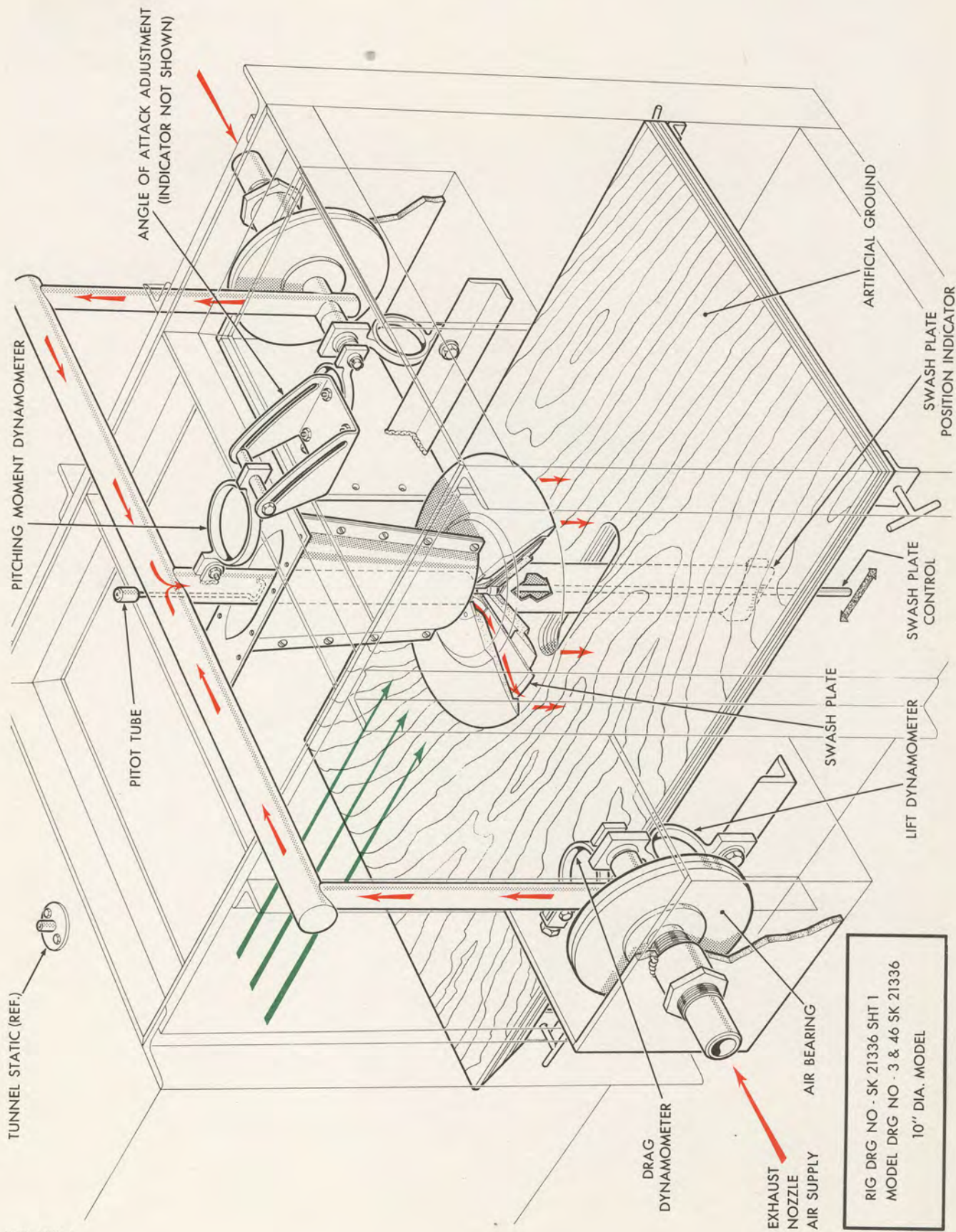


SUBSONIC WIND TUNNEL DRWG.
NO. SK 21316 SHT 1-4
SUPERSONIC WIND TUNNEL LINER DRWG.
NO. SK 30193 SHT 1-7

1503-1794-1

APRIL 15, 1956

FIG. 30 INSTALLATION OF SUPERSONIC LINER IN AVRO SUBSONIC EJECTOR WIND TUNNEL

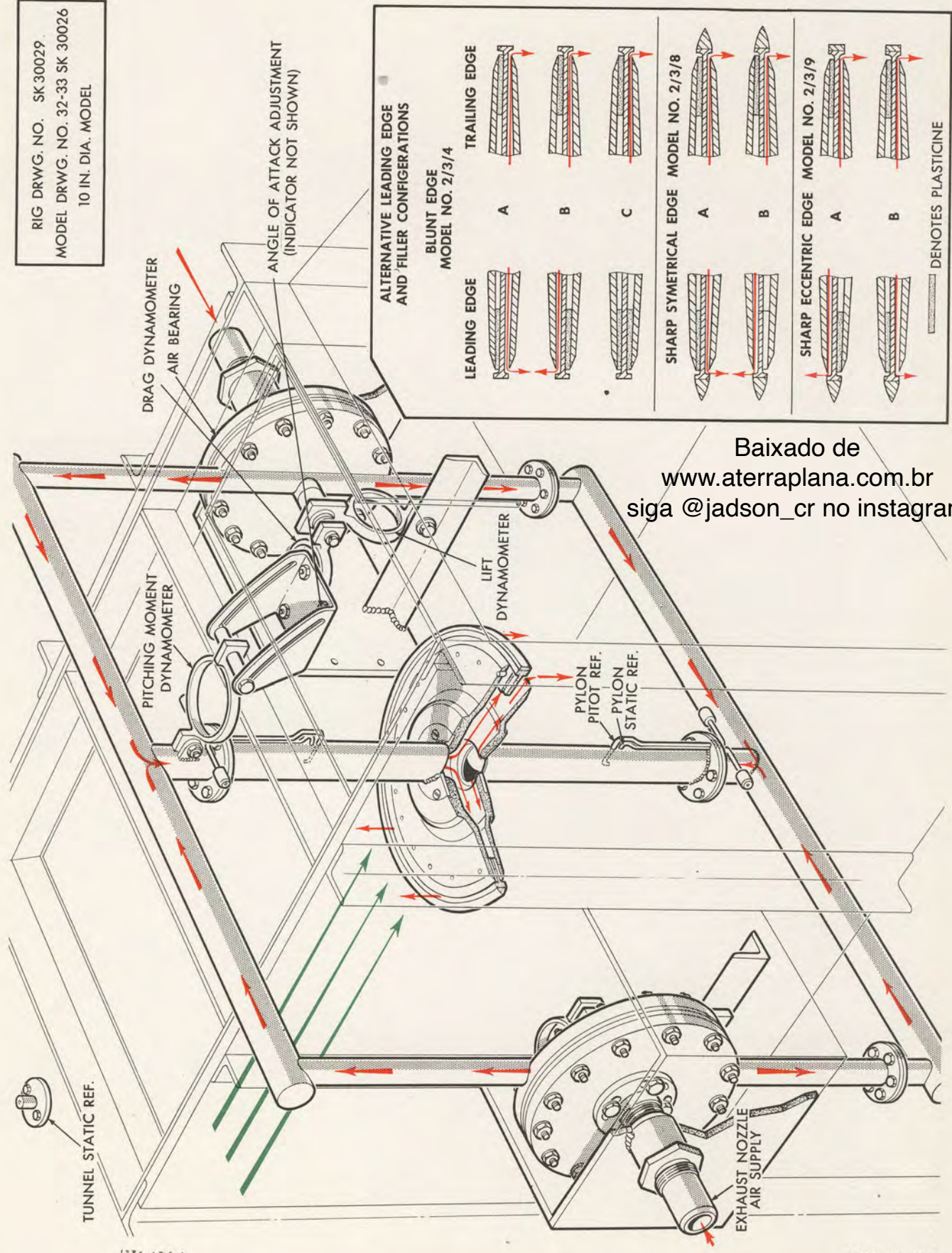


1228-1794-1

APRIL 15, 1956

FIG. 31 AIR CUSHION EFFECTS MODEL NO. 1/1/1

RIG DRWG. NO. SK 30029.
MODEL DRWG. NO. 32-33 SK 30026
10 IN. DIA. MODEL



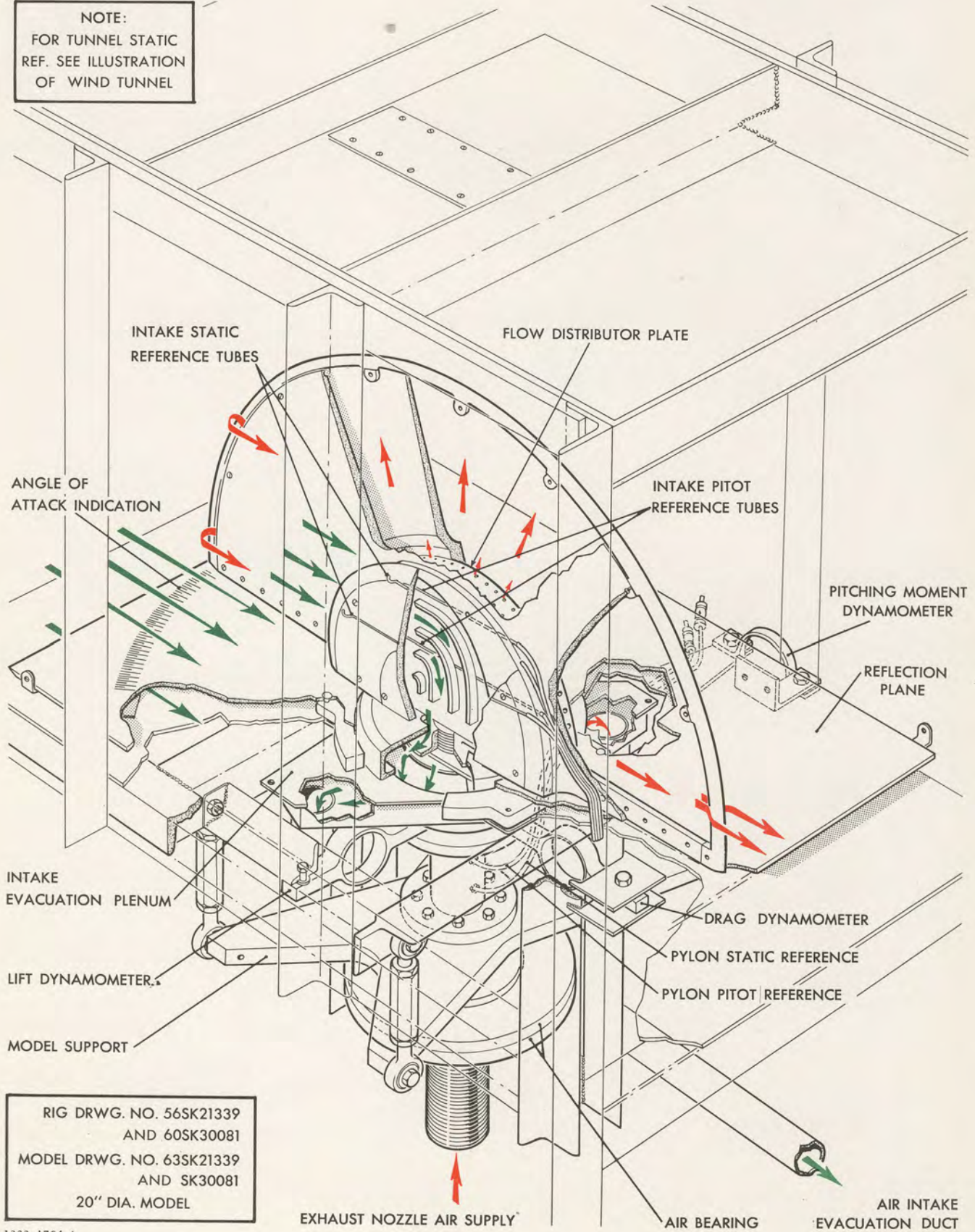
Baixado de
www.aterraplana.com.br
siga @jadson_cr no instagram

1236-1794

APRIL 15, 1956

FIG. 32 STABILITY AND CONTROL MODELS NO. 2/3/4, 2/3/8 AND 2/3/9

NOTE:
FOR TUNNEL STATIC
REF. SEE ILLUSTRATION
OF WIND TUNNEL



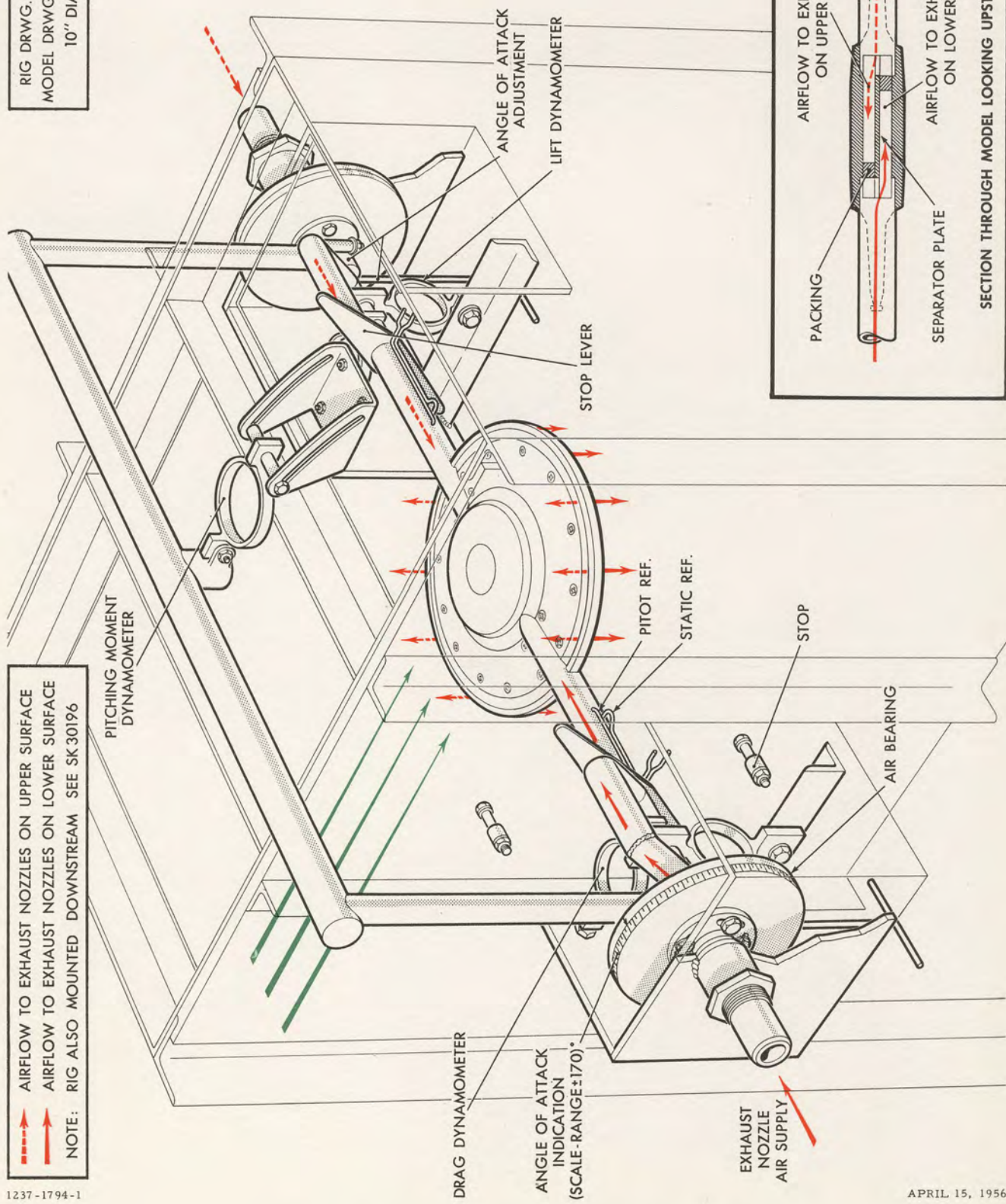
RIG DRWG. NO. 56SK21339
AND 60SK30081
MODEL DRWG. NO. 63SK21339
AND SK30081
20" DIA. MODEL

1232-1794-1

APRIL 15, 1956

FIG. 33 STABILITY AND CONTROL MODEL NO. 2/2/4

RIG DRWG. NO. SK 30064
MODEL DRWG. NO. 17SK30064
10" DIA. MODEL

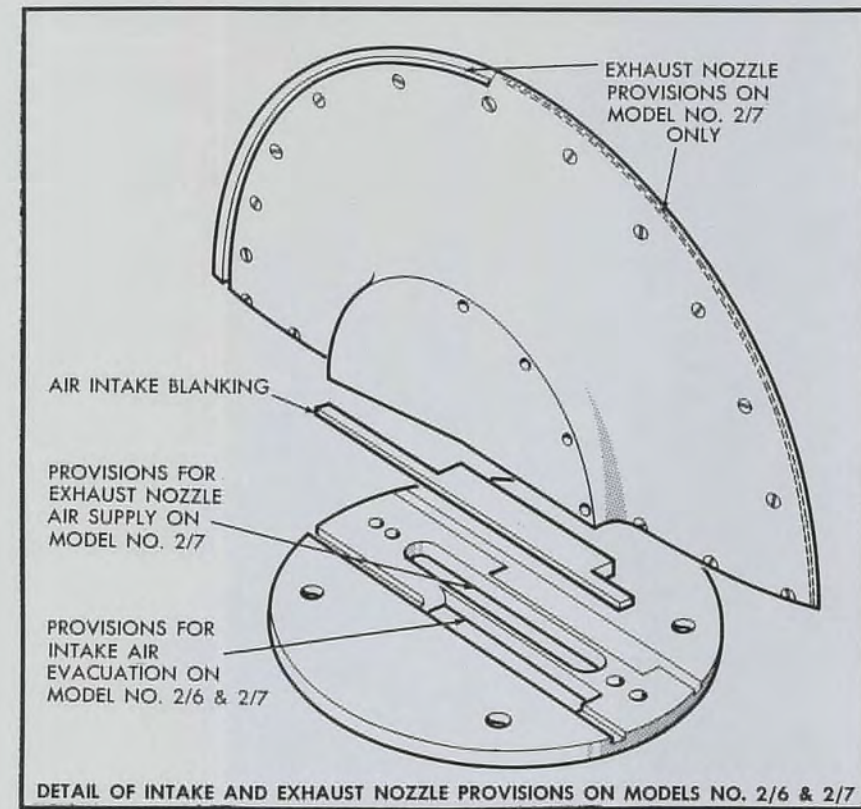
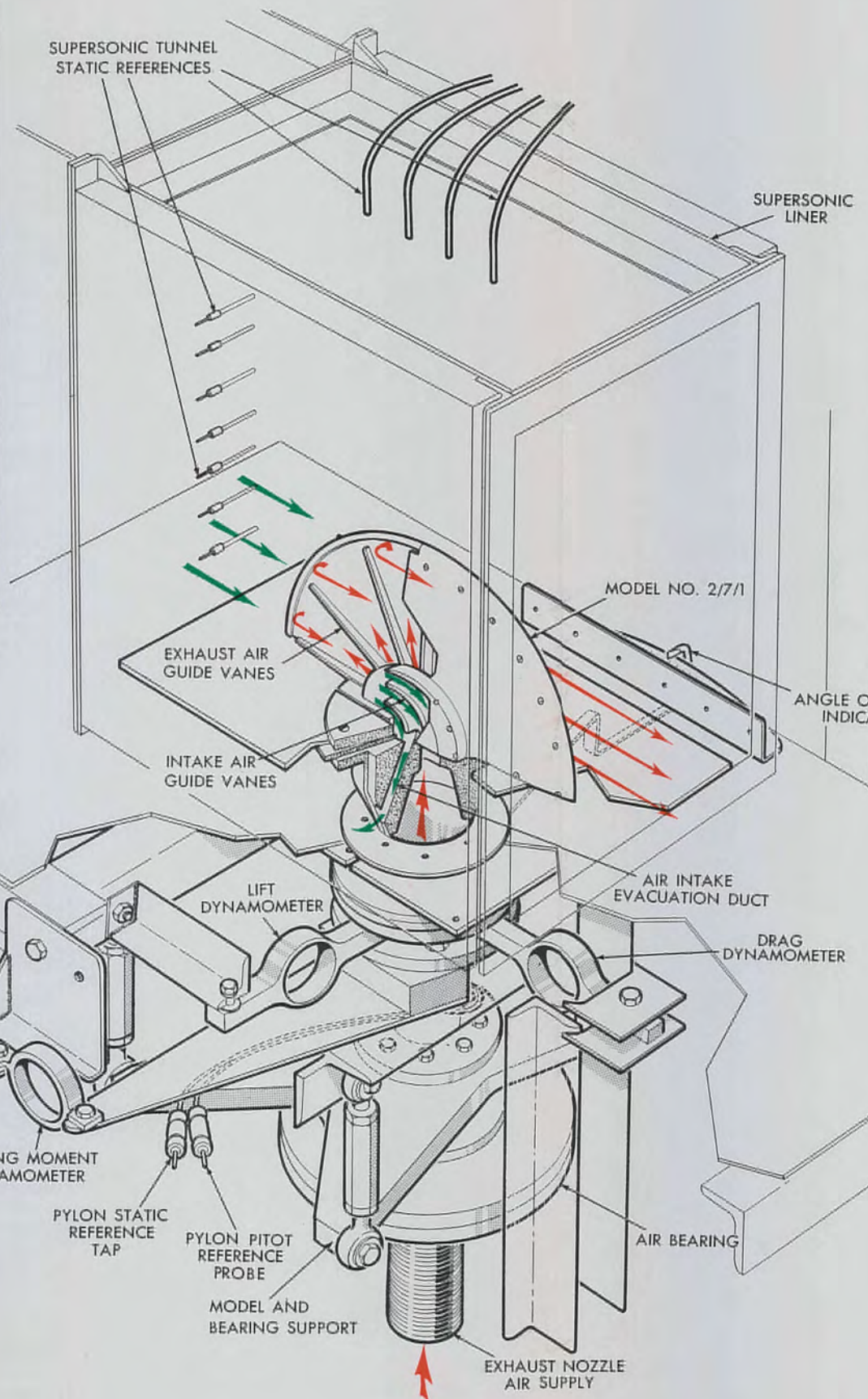
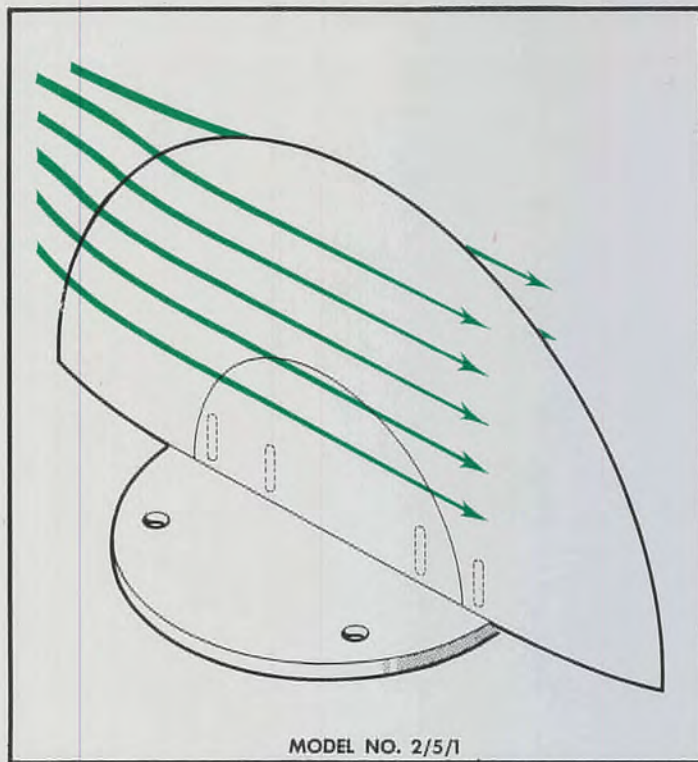


→ AIRFLOW TO EXHAUST NOZZLES ON UPPER SURFACE
 → AIRFLOW TO EXHAUST NOZZLES ON LOWER SURFACE
 NOTE: RIG ALSO MOUNTED DOWNSTREAM SEE SK 30196

1237-1794-1

APRIL 15, 1956

FIG. 34 STABILITY AND CONTROL MODEL NO. 2/4/1



RIG DRWG. NOS. SK30195 SHT 1
20SK21339

MODEL DRWG. NOS. 2/5 25K30195
2/6 35K30195
2/7 45K30195

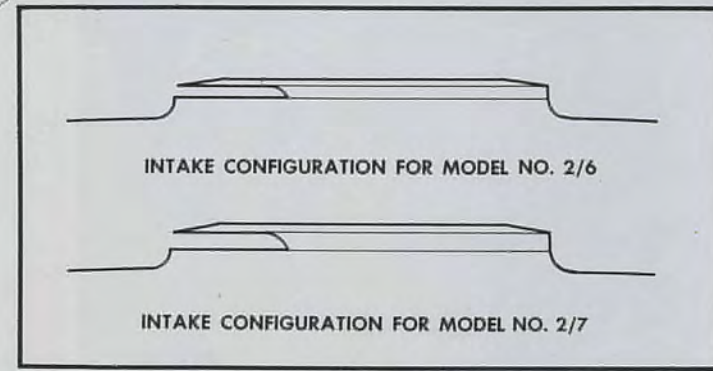
9" DIA. MODEL

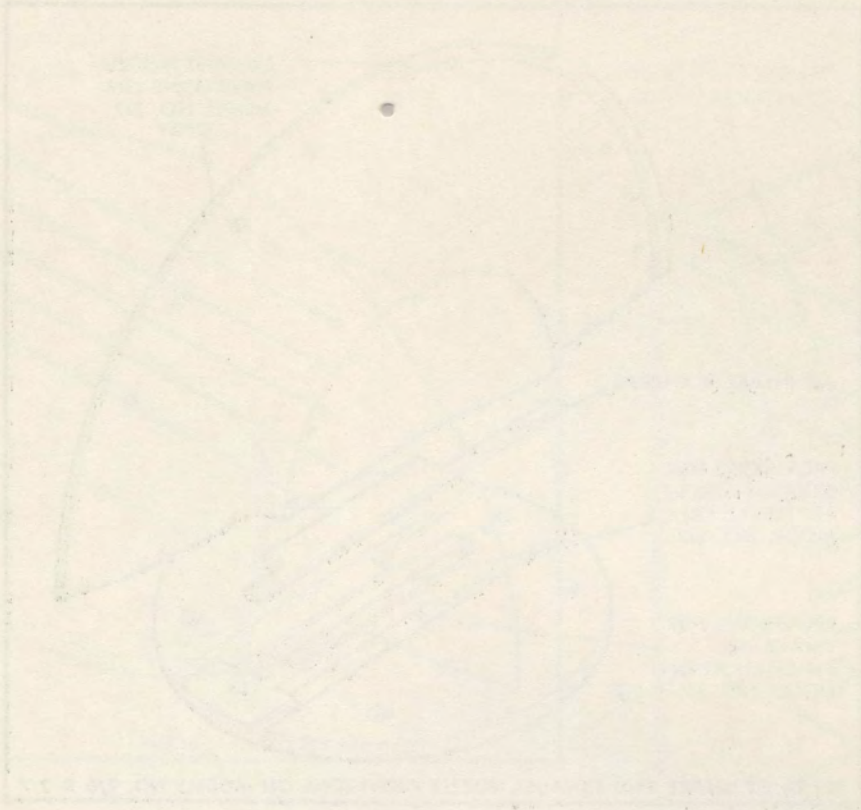
NOTE

1. MODEL NO. 2/6/1 WHICH IS NOT ILLUSTRATED IN FULL HAD A SOLID WING AND INTAKE ROOF INSTALLED AS NOTED
2. MODEL NO. 2/6/2 IS MODEL NO. 2/6/1 WITH INTAKE ROOF REMOVED AND INTAKE DUCTS BLOCKED OFF
3. MODEL NO. 2/7/2 IS MODEL NO. 2/7/1 WITH INTAKE ROOF REMOVED AND INTAKE DUCTS BLOCKED OFF

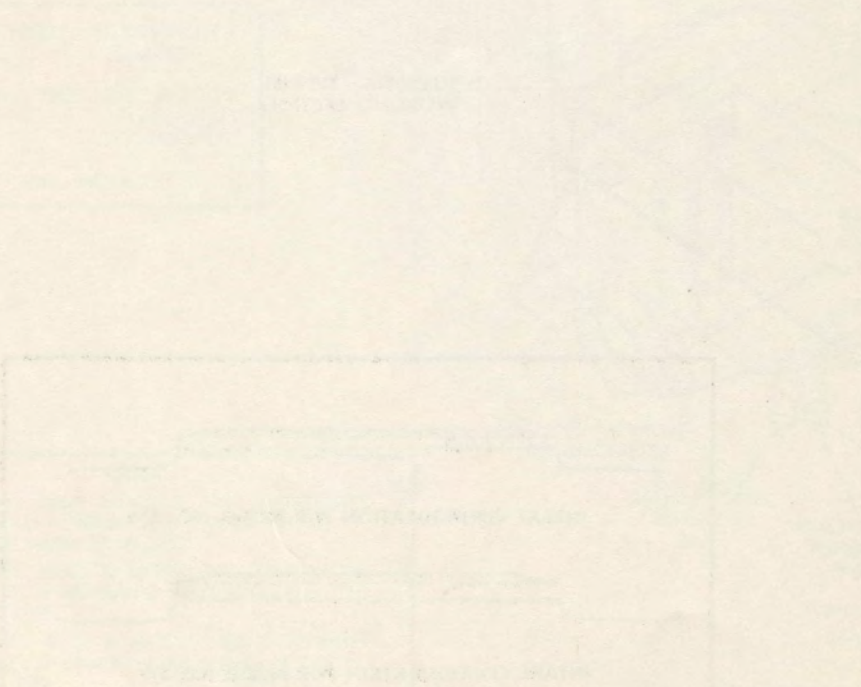
1238-1794-1

Baixado de
www.ateraplana.com.br
siga @jadson_cr no instagram





RIC
MC



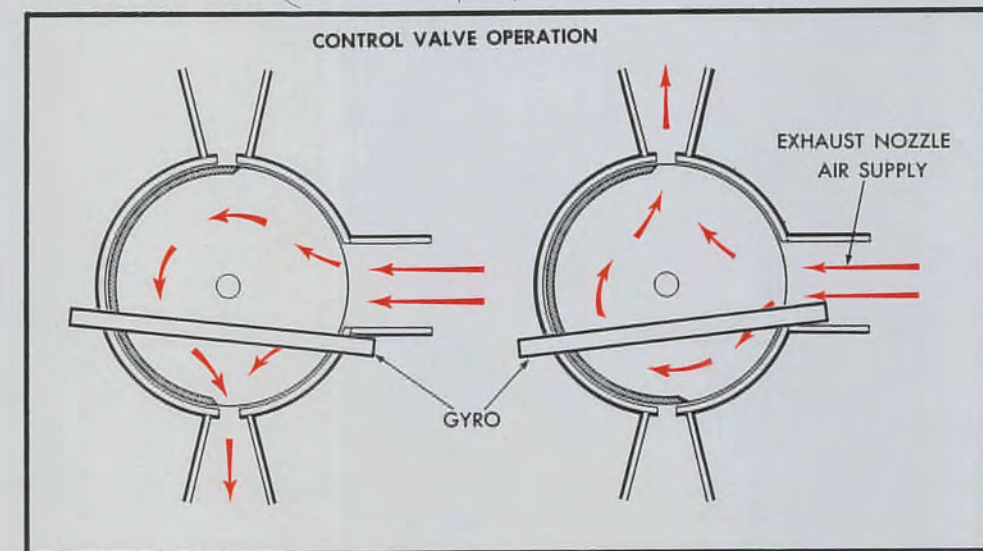
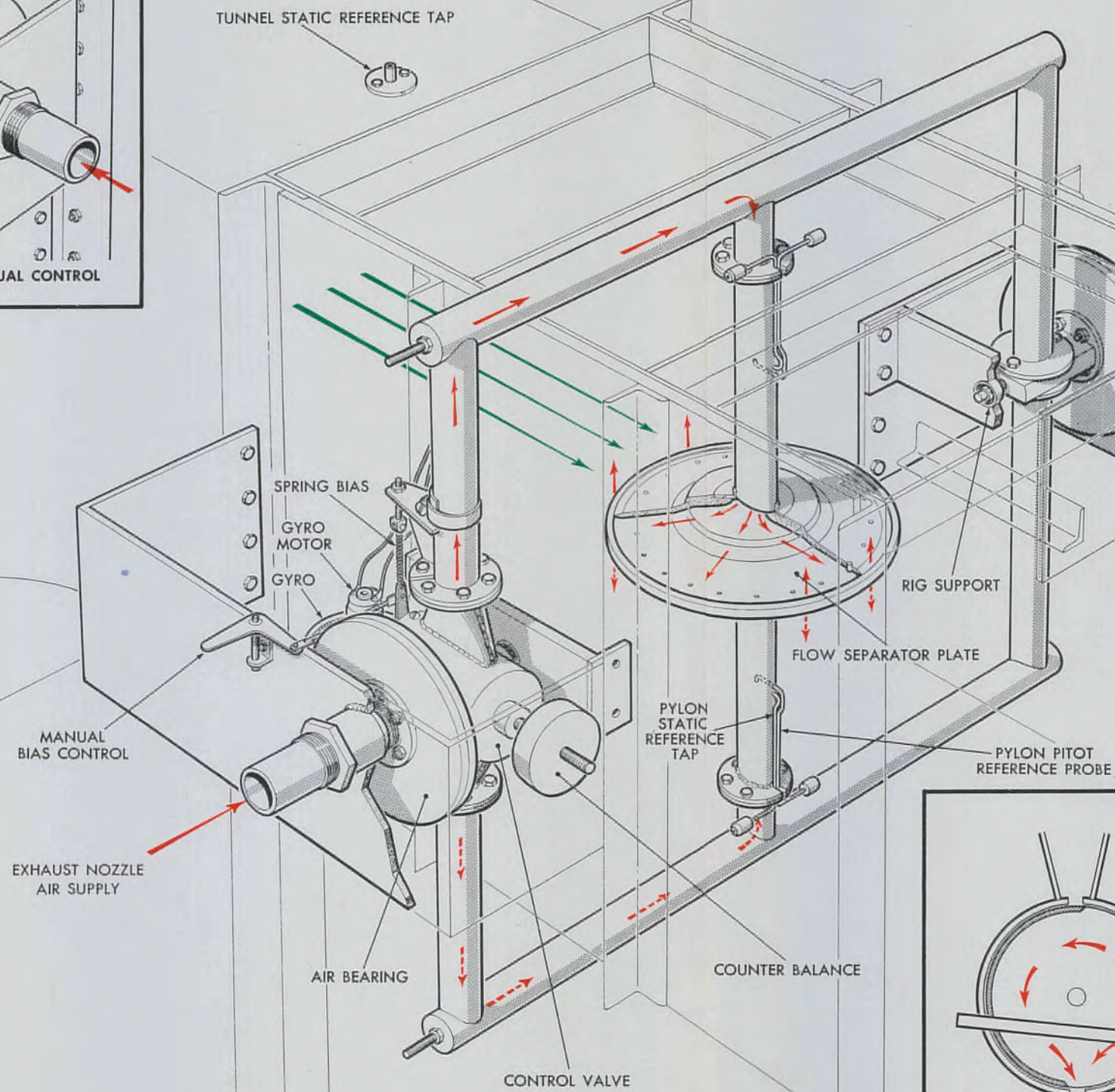
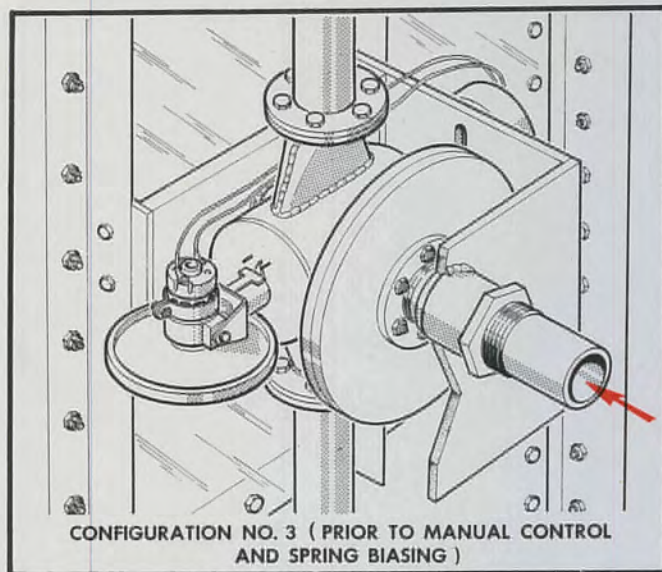
- 1.
- 2.
- 3.

FIG. 35

STABILITY AND CONTROL MODELS NO. 2/5, 2/6 AND 2/7

1238-1'

~~SECRET~~



RIG DRG. NO. SK30069
MODEL DRG. NO. 17 SK 30026
10 IN. DIA. MODEL

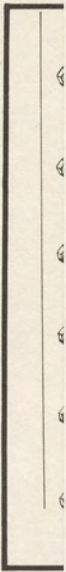
1235-1794-2

CONFIGURATION NO. 10 AS SHOWN

Revised May 18, 1956

STABILITY AND CONTROL MODEL NO. 2/3/3 AND 2/3/10 (WITH TWO DEGREES OF FREEDOM)

~~SECRET~~



R
MO

1235-17

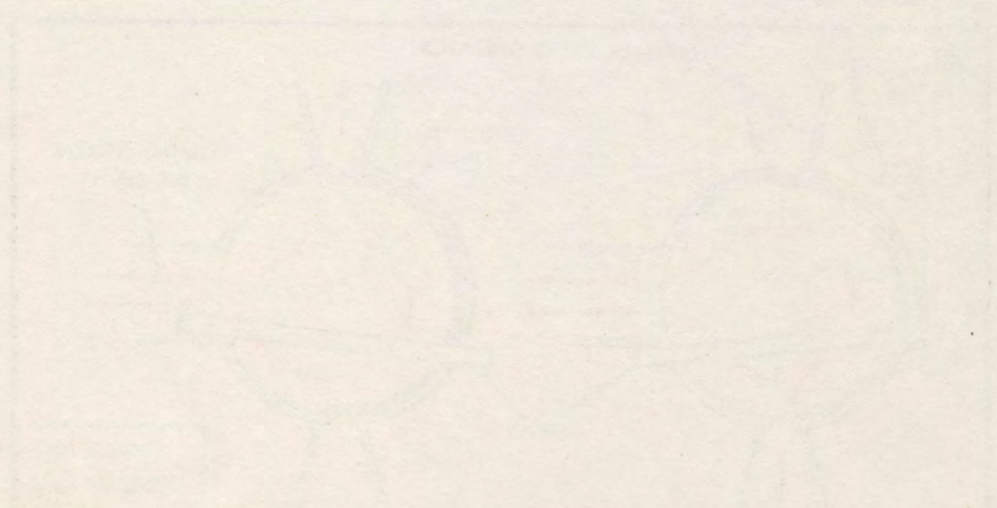
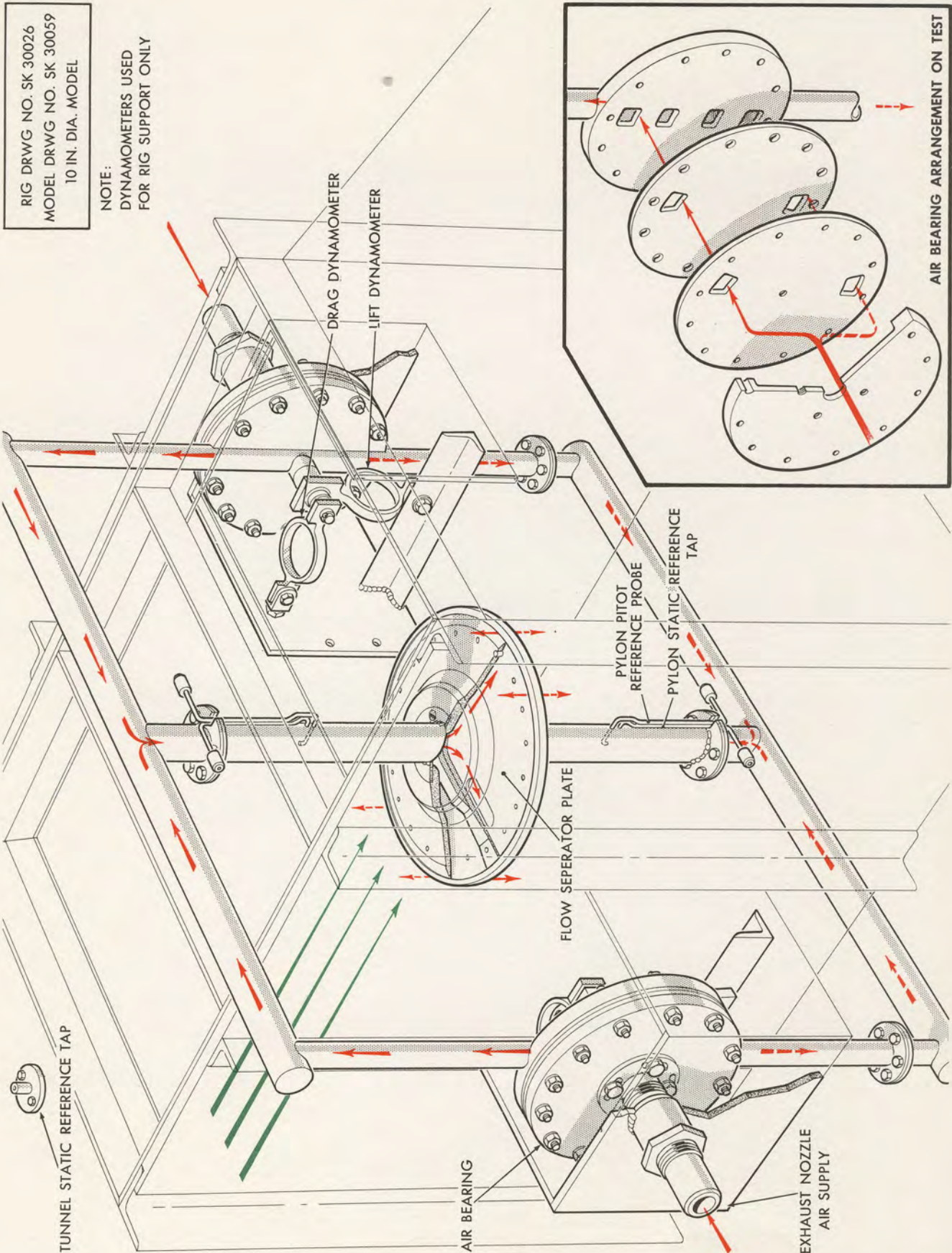


FIG. 36

STABILITY AND CONTROL MODEL NO. 2/3/3 AND 2/3/10 (WITH TWO DEGREES OF FREEDOM)



RIG DRWG NO. SK 30026
 MODEL DRWG NO. SK 30059
 10 IN. DIA. MODEL

NOTE:
 DYNAMOMETERS USED
 FOR RIG SUPPORT ONLY

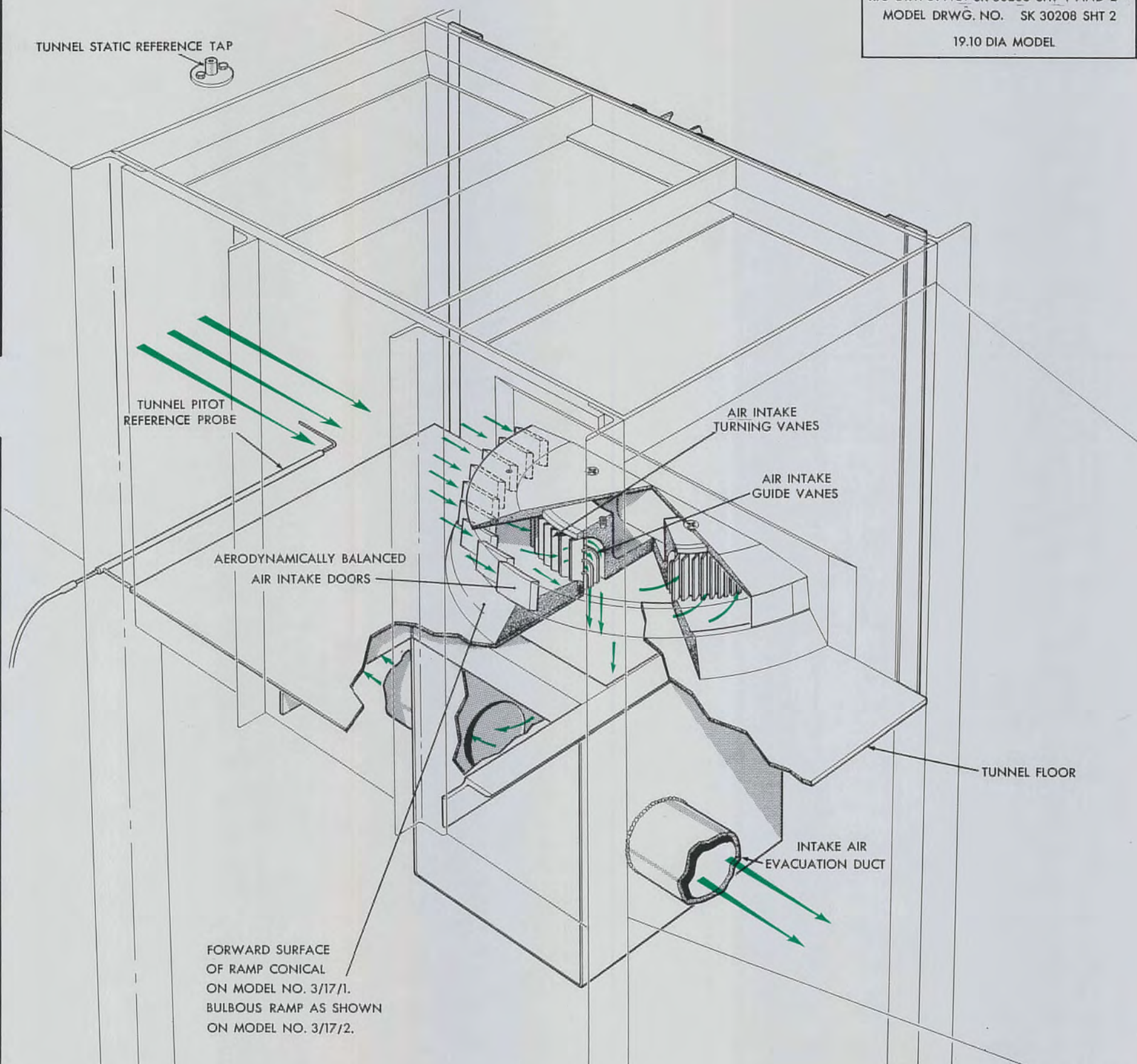
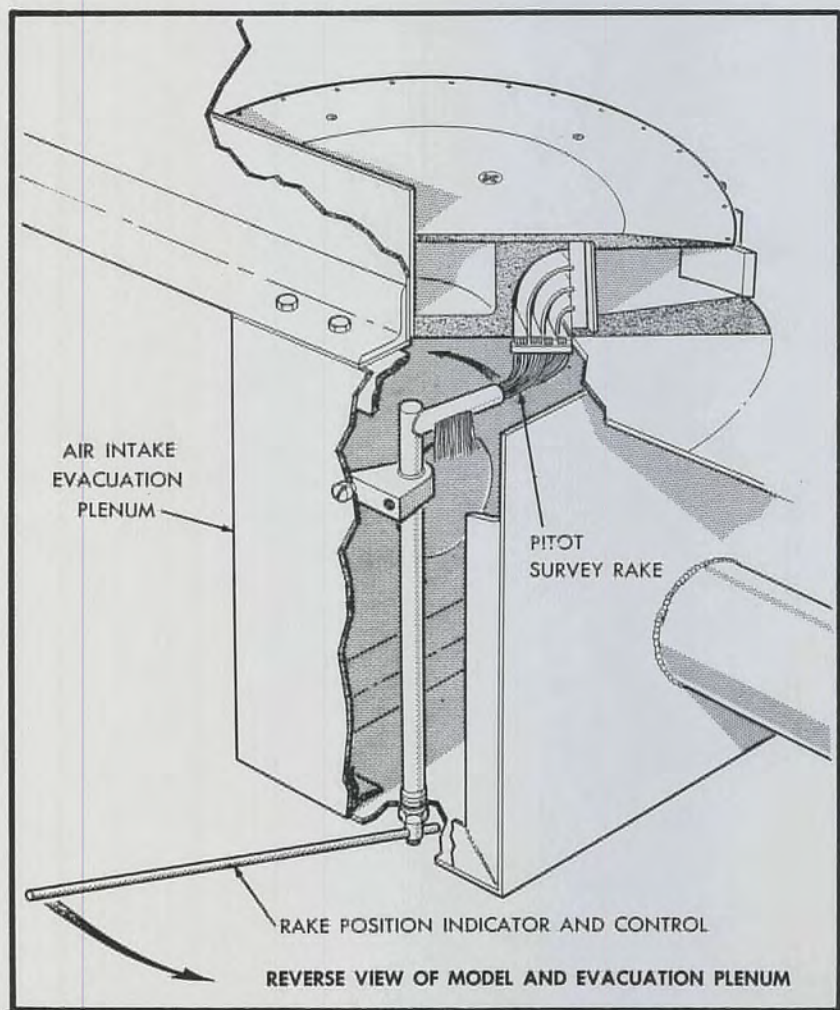
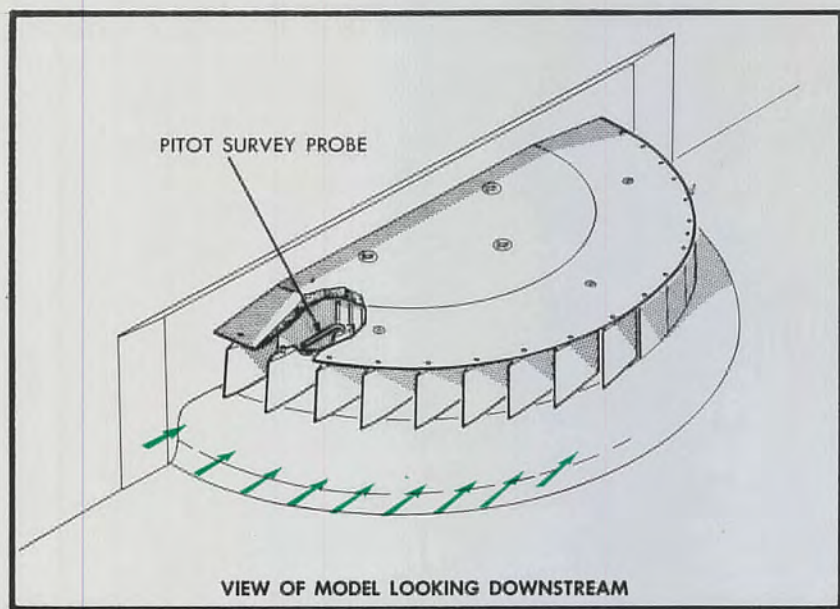
AIR BEARING ARRANGEMENT ON TEST

1371-1794-7

Revised May 18, 1956

FIG. 37 STABILITY AND CONTROL MODEL NO. 2/3/12 (WITH TWO DEGREES OF FREEDOM)

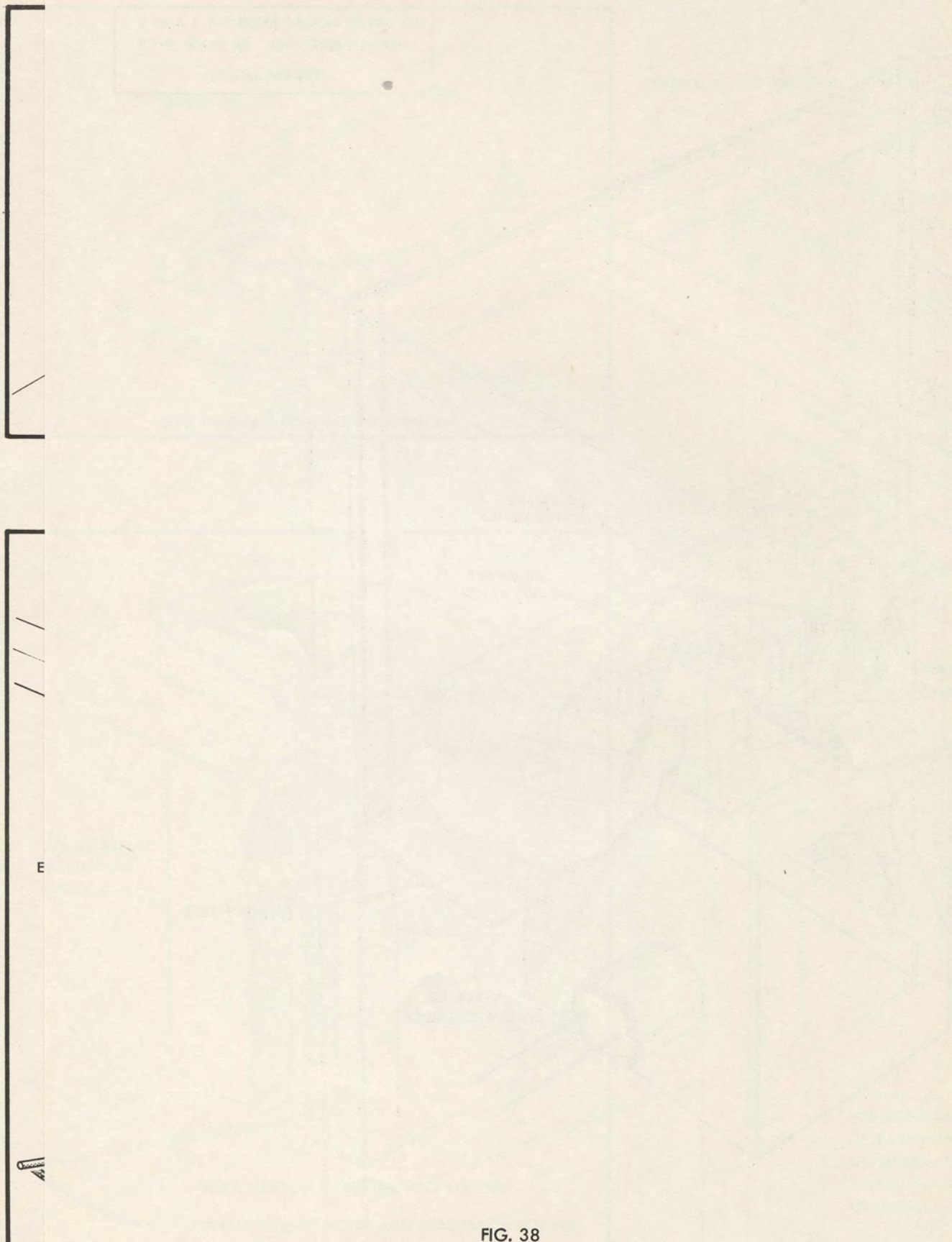
RIG DRWG. NO. SK 30208 SHT 1 AND 2
MODEL DRWG. NO. SK 30208 SHT 2
19.10 DIA MODEL



1246-1794-2

MAY 2, 1956

AIR INTAKE AND GAS EXHAUST SYSTEM MODEL NO. 3/17/1 AND 3/17/2



E

FIG. 38

AIR INTAKE AND GAS EXHAUST SYSTEM MODEL NO. 3/17/1 AND 3/17/2

1246-1

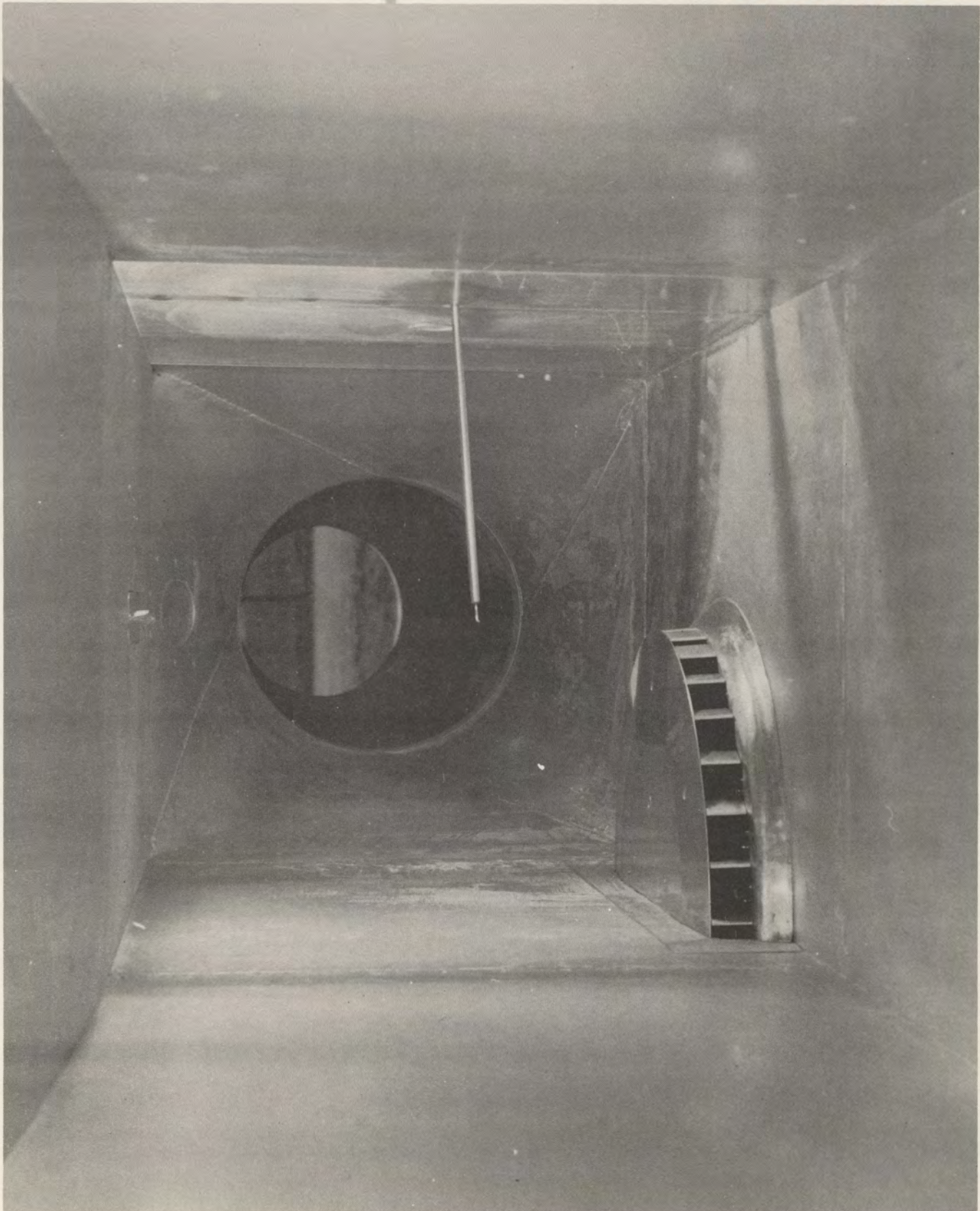


FIG. 39 INTERNAL FLOW INTAKE MODEL

5.1.1.3
(Cont'd)

The dynamic models are illustrated in Figs. 36 and 37. These did not give quantitative data; in general the following behaviour was observed:

- (i) The displacement model showed static stability over a satisfactory angle of attack range, the angle of attack being controlled by the port setting supplying the controlling jets. Damping was poor, attributed to the restraint in the model from rise and fall.
- (ii) The rate model did not show dynamic stability but could easily be controlled with the additional pitch damping provided by the jets.

The present design incorporates both rate and displacement signals (Page 11). Additional tests and dimensional analysis of this type of model is desirable to investigate the dual control system.

The air intake internal airflow model is illustrated in Fig. 38-39. Due to a series of delays this model was not tested until late in the contract period. It was designed to obtain data on the pressure recovery and flow distribution to the eye of the impeller.

The following broad conclusions were reached:

- (i) In the static case pressure recovery and flow distribution were satisfactory and in accordance with the static thrust estimate.
- (ii) In forward flight pressure recovery to the front and rear

5.1.1.3
(Cont'd)

sectors was satisfactory but flow distribution was unsatisfactory and the flow was not directed into the eye of the impeller at the side by the vertical cascades.

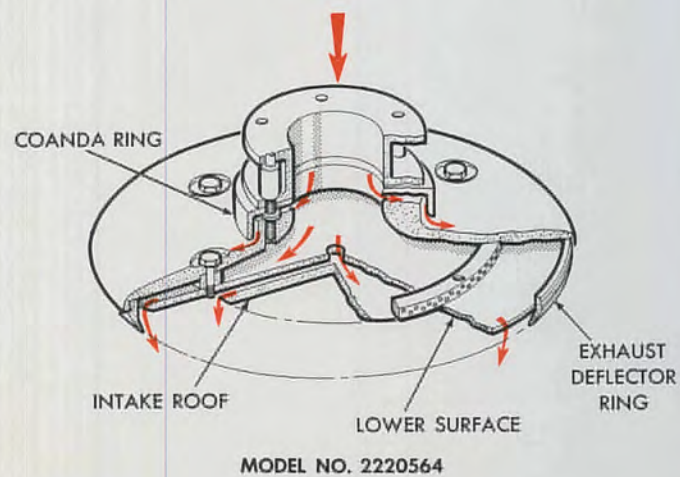
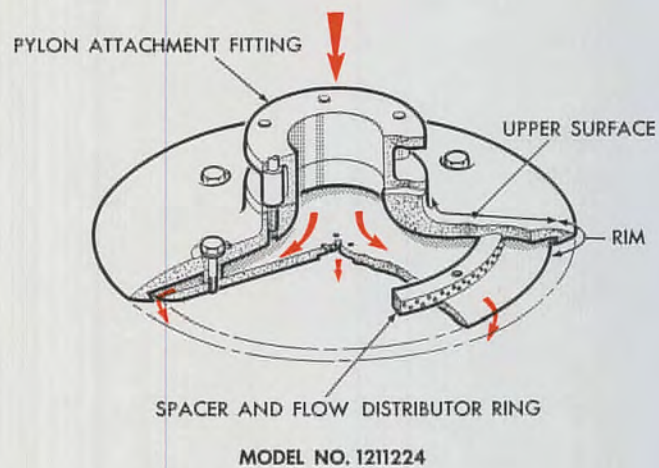
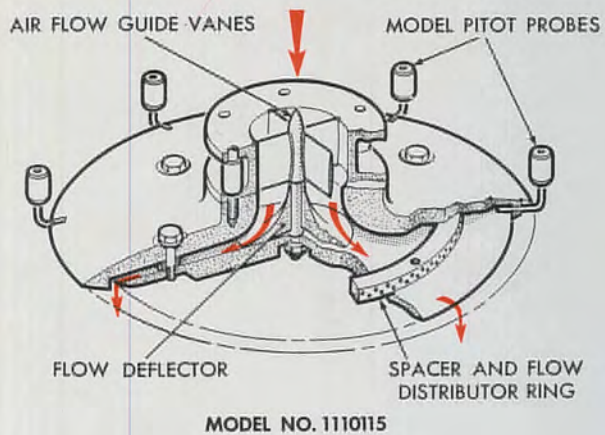
(iii) Internal flow air intake tests at the small scale which the contractor's tunnel imposes are not satisfactory. Apart from the low Reynolds No., (particularly based on the chord of tiny cascades) the manufacturing difficulties of obtaining accurate flow passages are severe.

Further tests at larger scale are required to develop the internal air intake flow. An attractive alternative with radial cascades out to the intake edge is envisaged. It also seems likely that the intake flow will be much improved if some pre-swirl into the impeller eye is allowed and this is seen as a distinct advantage in the design of the impeller.

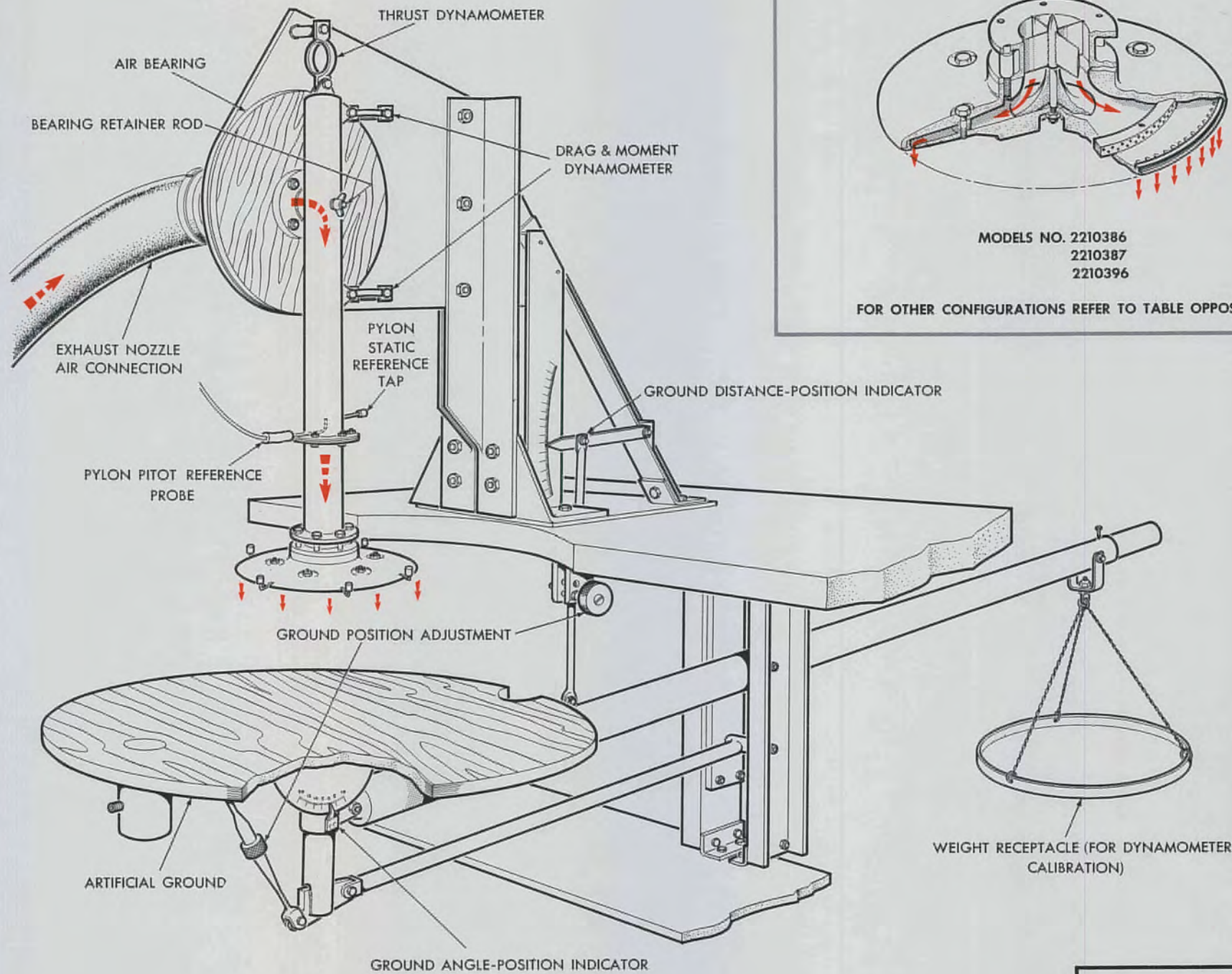
5.1.2 Air Cushion Effect Tests: Apart from the air cushion effect phase of the 1/6th scale subsonic model tests (Page 20) two series of tests have been carried out at Malton on a static rig. The first series (Figs. 40 and 41) was done on 10" diameter models and the second (Figs. 42 and 43) on 20" diameter models (four times the area and mass flow). The application of a peripheral jet to a delta shape (Fig. 44), the unsatisfactory result of having a wind^g-around-jet configuration (Fig. 45), and the effect of a hot central exhaust have also been tested. The tests

~~SECRET~~

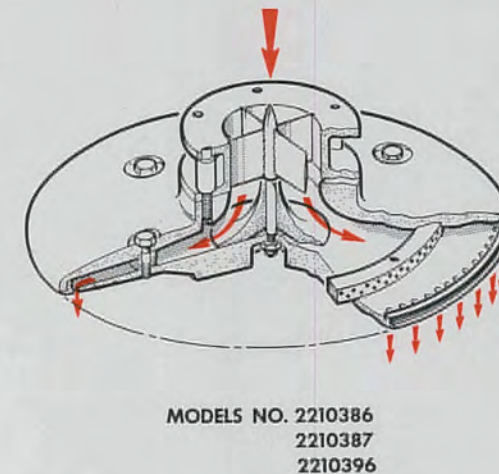
TYPICAL MODEL CONFIGURATIONS



FOR OTHER CONFIGURATIONS REFER TO TABLE OPPOSITE



TYPICAL MODEL CONFIGURATIONS



FOR OTHER CONFIGURATIONS REFER TO TABLE OPPOSITE

RIG DRWG. NO. SK 21295
MODEL DRWG. NO. 50SK 21295
104SK21925
10" DIA. MODELS

Revised May 23, 1956

1223-1794-2

AIR CUSHION EFFECTS MODEL NO. 1/8

~~SECRET~~

~~SECRET~~

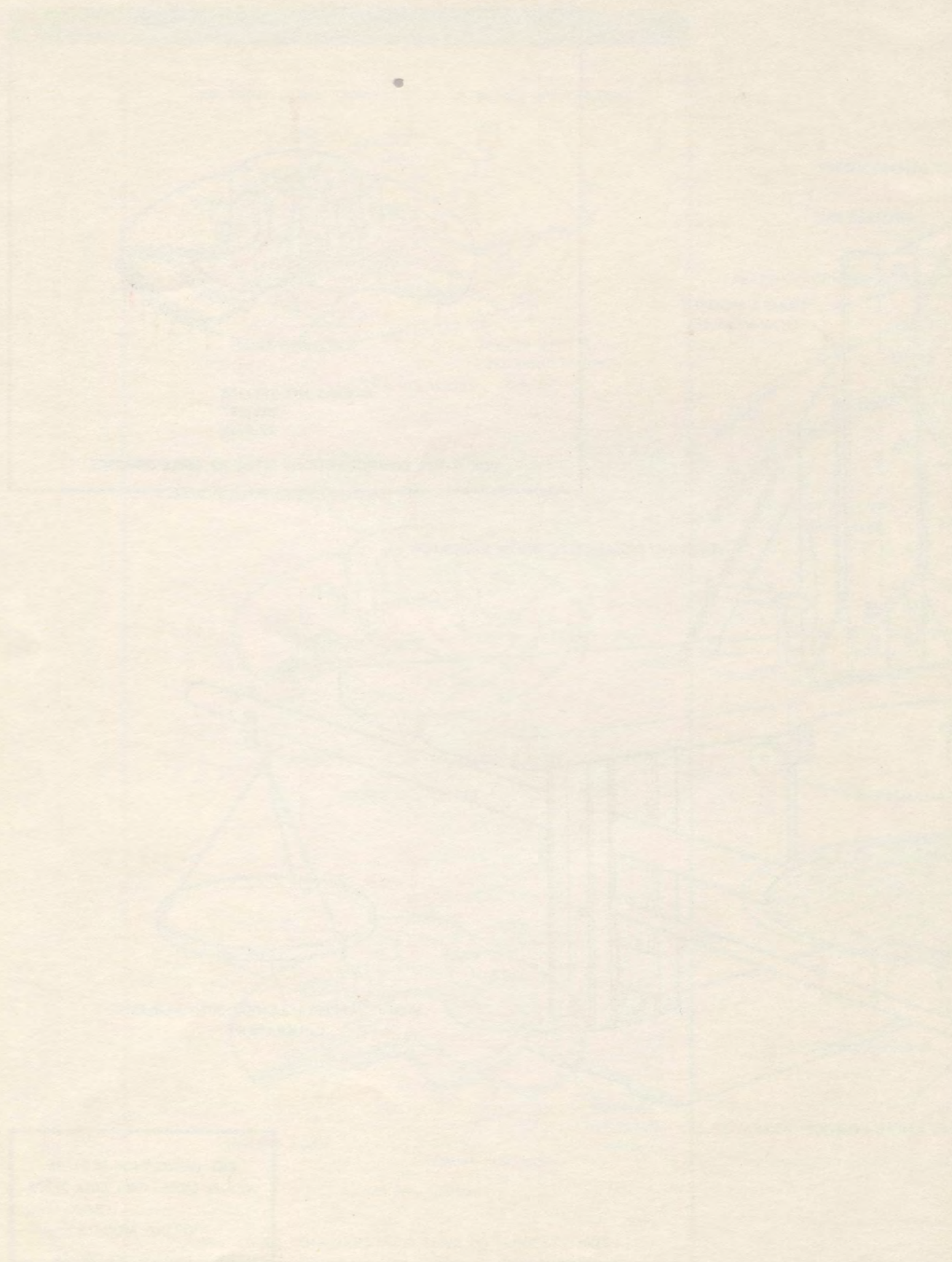
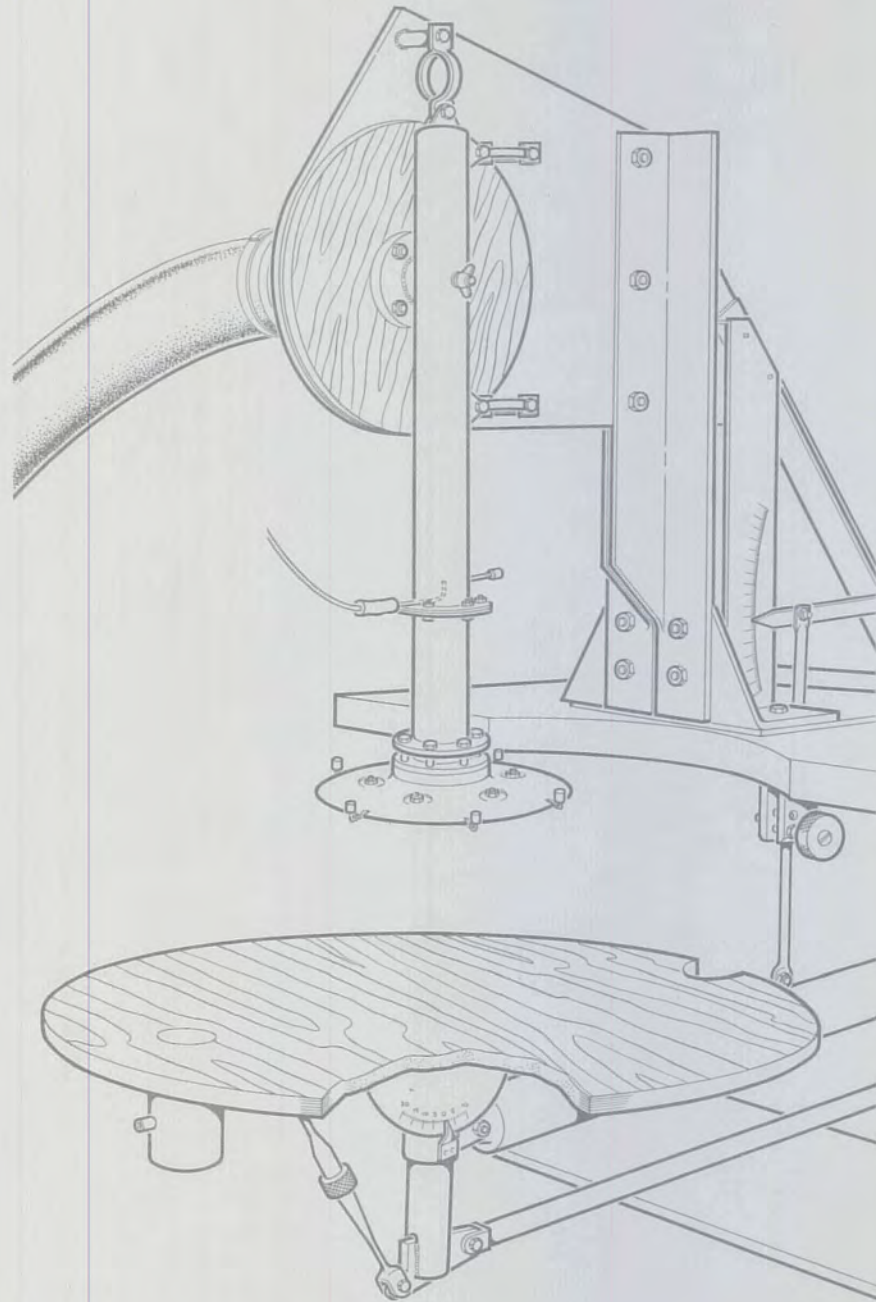


FIG. 40

AIR CUSHION EFFECTS MODEL NO. 1/8

~~SECRET~~

Baixado de
www.ateraplana.com.br
siga @jadson_cr no instagram



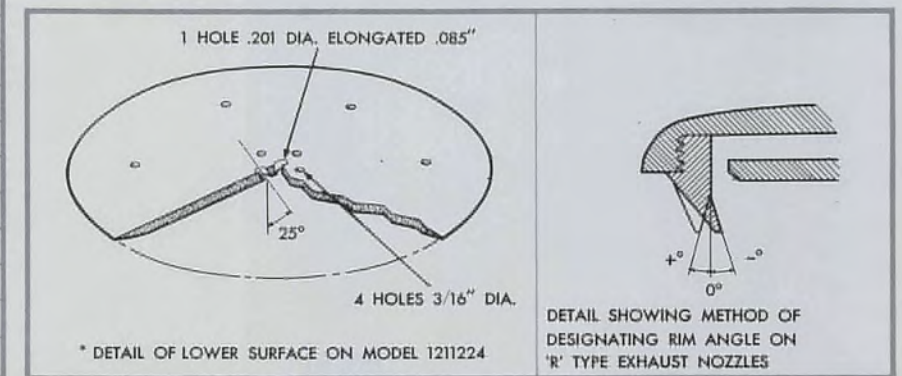
ILLUSTRATIVE KEY TO BASIC VARIATIONS IN GEOMETRY

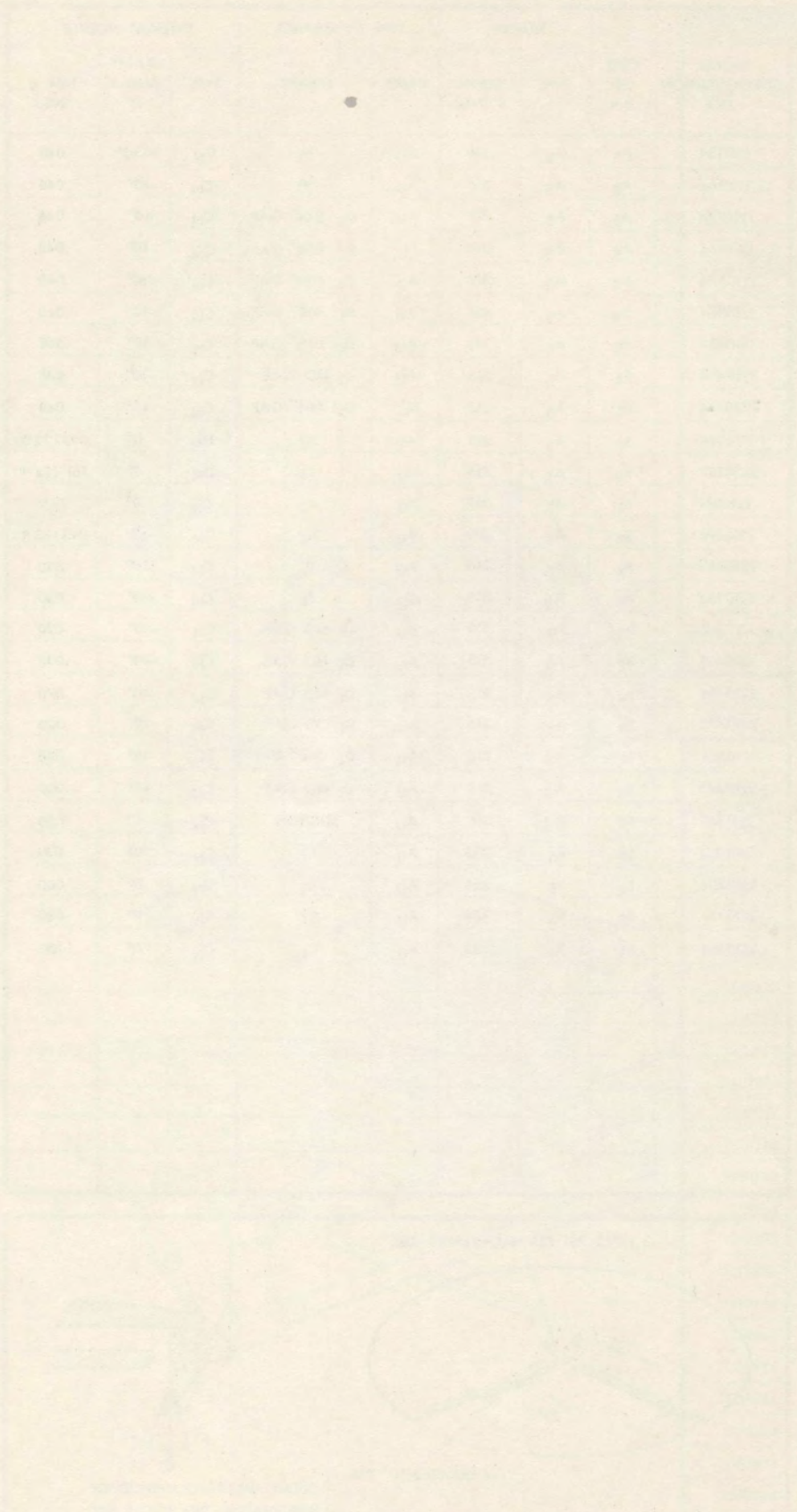
TYPE OF RIM	A _R	B _R	C _R	D _R
TYPE OF SPACER	A _S	B _S	C _S	D _S
TYPE OF UPPER SURFACE	A _U	B _U	C _U	D _U
TYPE OF LOWER SURFACE	A _L	B _L	C _L	D _L
	E _L	F _L	G _L	H _L
	J _L	K _L	M _L	N _L
TYPE OF EXHAUST NOZZLE	A _N	B _N	C _N	D _N

† NUMBER OF HOLES

MODEL CONFIGURATION NO.	TYPE OF RIM	SPACER		TYPE OF SURFACE		EXHAUST NOZZLE		
		TYPE	DEPTH d (INS.)	UPPER	LOWER	TYPE	OUTLET ANGLE 0°	DIM. g (INS.)
1110115	A _R	A _S	.355	A _U	A _L	A _N	—	.070
1211224	A _R	A _S	.315	A _U	J _L	B _N	—	.048
1210224	A _R	A _S	.315	A _U	B _L	B _N	—	.048
1410224	A _R	B _S	.275	A _U	B _L	B _N	—	.048
1310224	A _R	B _S	.315	A _U	B _L	B _N	—	.048
1210924	A _R	A _S	.315	A _U	F _L	B _N	—	.048
1410924	A _R	B _S	.275	A _U	F _L	B _N	—	.048
1210234	A _R	A _S	.315	A _U	B _L	C _N	+13.5°	.048
1210244	A _R	A _S	.315	A _U	B _L	C _N	+5°	.048
1210254	A _R	A _S	.315	A _U	B _L	C _N	0°	.048
1210264	A _R	A _S	.315	A _U	B _L	C _N	-10°	.048
1210274	A _R	A _S	.315	A _U	B _L	C _N	-20°	.048
1210934	A _R	A _S	.315	A _U	F _L	C _N	+13.5°	.048
1210954	A _R	A _S	.315	A _U	F _L	C _N	0°	.048
1210964	A _R	A _S	.315	A _U	F _L	C _N	-10°	.048
1210974	A _R	A _S	.315	A _U	F _L	C _N	-20°	.048
1211054	A _R	A _S	.315	A _U	G _L	C _N	0°	.048
1211064	A _R	A _S	.315	A _U	G _L	C _N	-10°	.048
1211074	A _R	A _S	.315	A _U	G _L	C _N	-20°	.048
1210254	A _R	A _S	.315	A _U	B _L	C _N	0°	.048
1210834	A _R	A _S	.315	A _U	E _L	C _N	+13.5°	.048

MODEL CONFIGURATION NO.	TYPE OF RIM	SPACER		TYPE OF SURFACE		EXHAUST NOZZLE		
		TYPE	DEPTH d (INS.)	UPPER	LOWER	TYPE	OUTLET ANGLE 0°	DIM. g (INS.)
1211134	A _R	A _S	.315	A _U	H _L	C _N	+13.5°	.048
1211164	A _R	A _S	.315	A _U	H _L	C _N	-10°	.048
1210744	A _R	A _S	.315	A _U	D _L .024" GAP	C _N	+5°	.048
1210764	A _R	A _S	.315	A _U	D _L .024" GAP	C _N	-10°	.048
1210774	A _R	A _S	.315	A _U	D _L .024" GAP	C _N	-20°	.048
1210664	A _R	A _S	.315	A _U	D _L .012" GAP	C _N	-10°	.048
1210564	A _R	A _S	.315	A _U	D _L .006" GAP	C _N	-10°	.048
2210464	B _R	A _S	.315	A _U	D _L NO GAP	C _N	-10°	.048
2220544	B _R	A _S	.315	B _U	D _L .006" GAP	C _N	+5°	.048
2210386	B _R	A _S	.315	A _U	C _L	D _N	0°	.093 (72 †)
2210387	B _R	A _S	.315	A _U	C _L	D _N	0°	.161 (24 †)
2210351	B _R	A _S	.315	A _U	C _L	C _N	0°	.015
2210396	B _R	A _S	.315	A _U	C _L	D _N	+5°	.093 (72 †)
2210262	B _R	A _S	.315	A _U	B _L	C _N	-10°	.020
2210263	B _R	A _S	.315	A _U	B _L	C _N	-10°	.030
2210462	B _R	A _S	.315	A _U	D _L NO GAP	C _N	-10°	.020
2210463	B _R	A _S	.315	A _U	D _L NO GAP	C _N	-10°	.030
2210465	B _R	A _S	.315	A _U	D _L NO GAP	C _N	-10°	.070
2210472	B _R	A _S	.315	A _U	D _L NO GAP	C _N	-20°	.020
2210564	B _R	A _S	.315	A _U	D _L .006" GAP	C _N	-10°	.048
2210443	B _R	A _S	.315	A _U	D _L NO GAP	C _N	+5°	.030
2211343	B _R	A _S	.315	A _U	SUCTION	C _N	+5°	.030
2510351	B _R	B _S	.235	A _U	C _L	C _N	0°	.040
2510352	B _R	B _S	.235	A _U	C _L	C _N	0°	.060
2510353	B _R	B _S	.235	A _U	C _L	C _N	0°	.080
2510354	B _R	B _S	.235	A _U	C _L	C _N	0°	.100



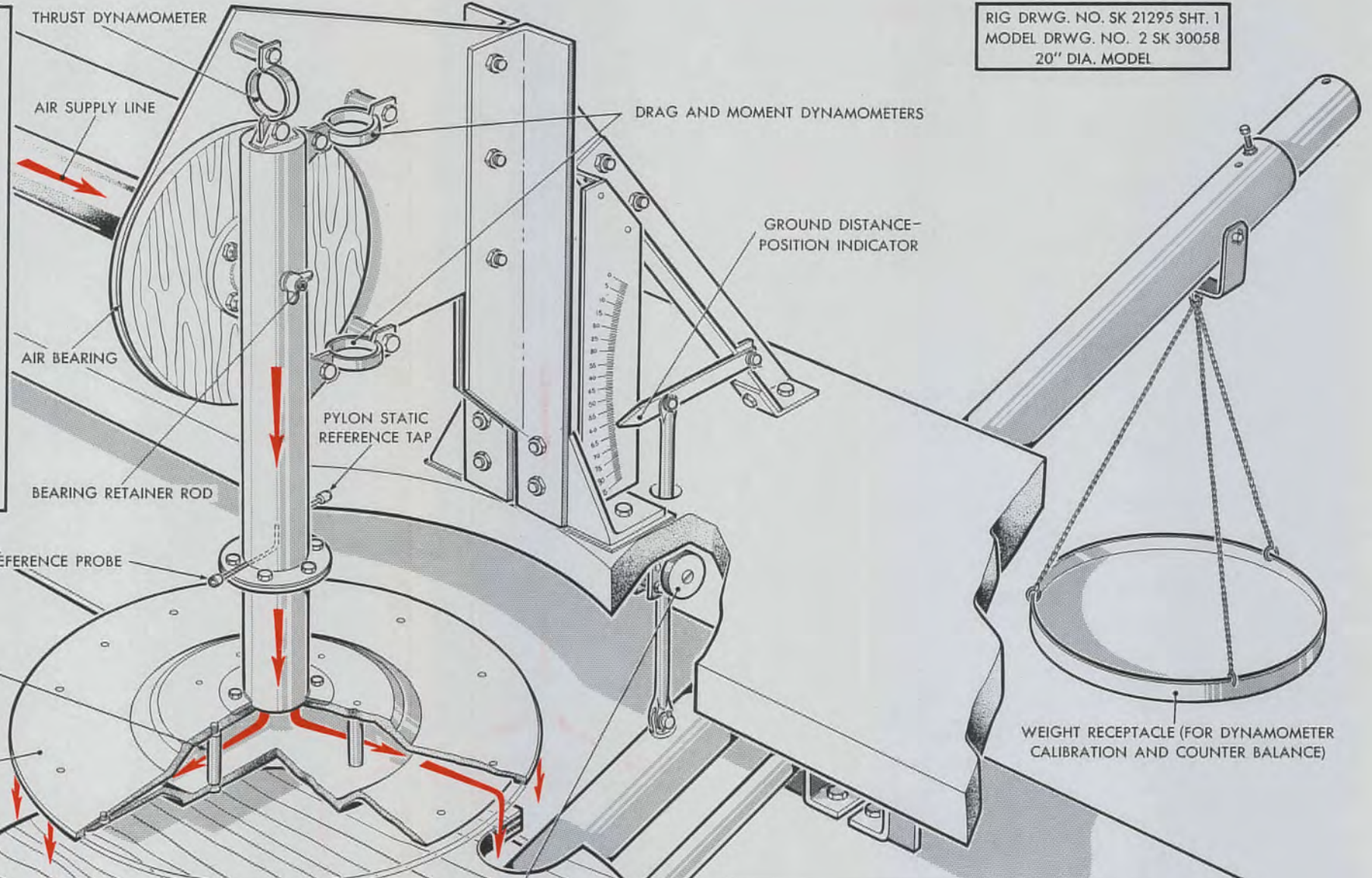
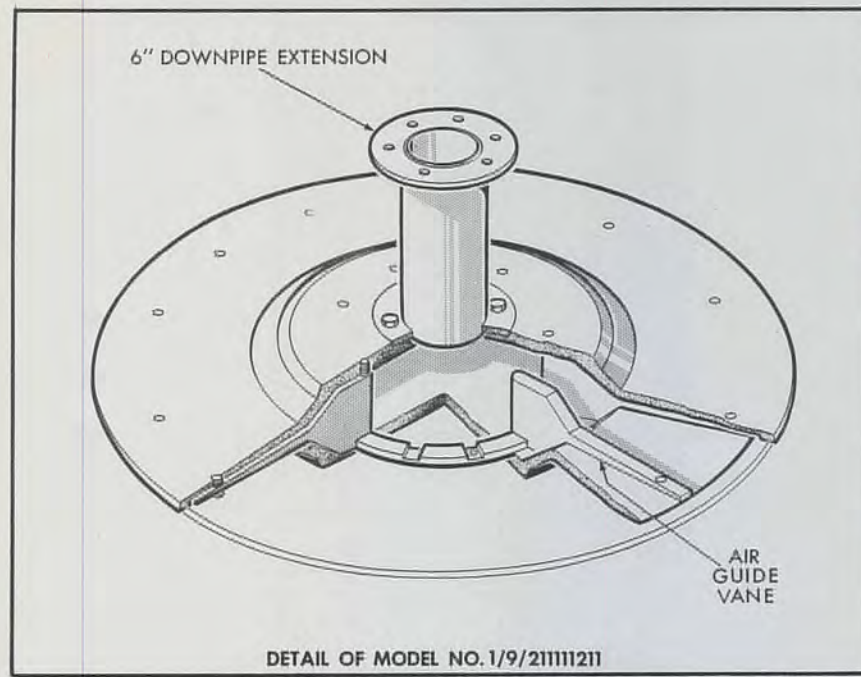


1551-17

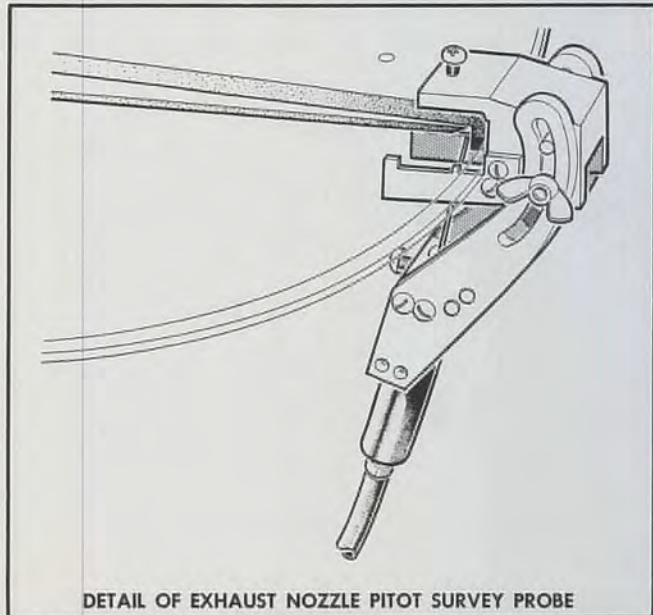
FIG. 41

MODEL NO. 1/8-CONFIGURATIONS TESTED

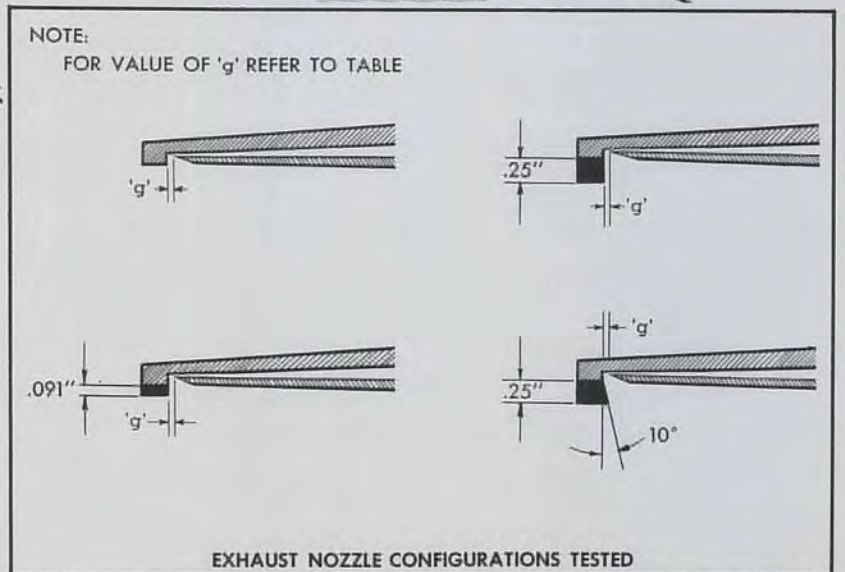
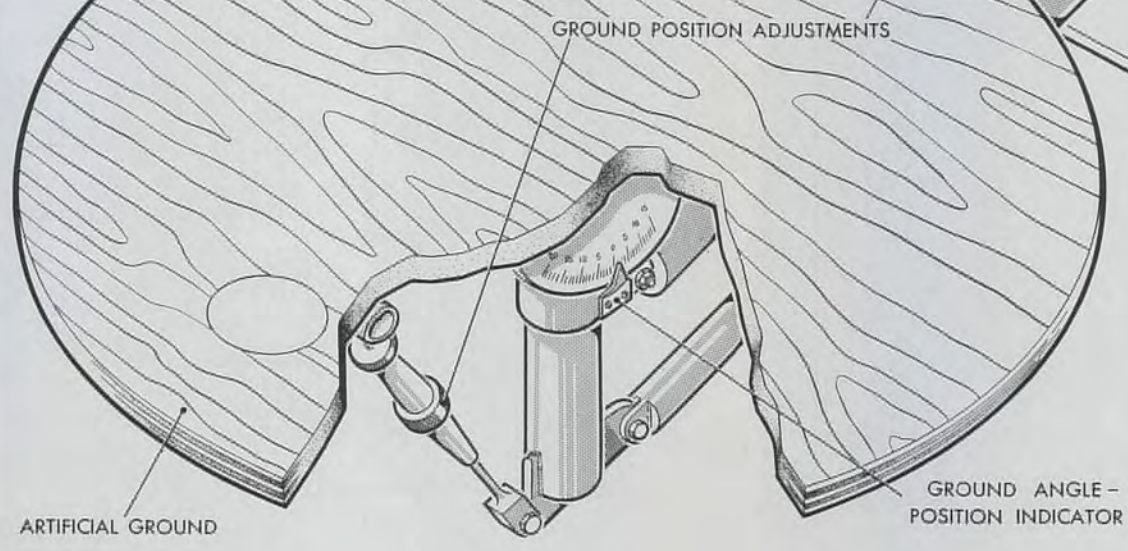
RIG DRWG. NO. SK 21295 SHT. 1
MODEL DRWG. NO. 2 SK 30058
20" DIA. MODEL



NOTE:
THIS IS SHEET NO. 1
FOR OTHER ILLUSTRATIONS REFER
TO SHEETS NO. 2, 3, ETC.
FOR DETAILS OF OTHER
CONFIGURATIONS AND LETTERED
DIMENSIONS REFER TO TABLE



MODEL NO. 1/9/21111211





NO

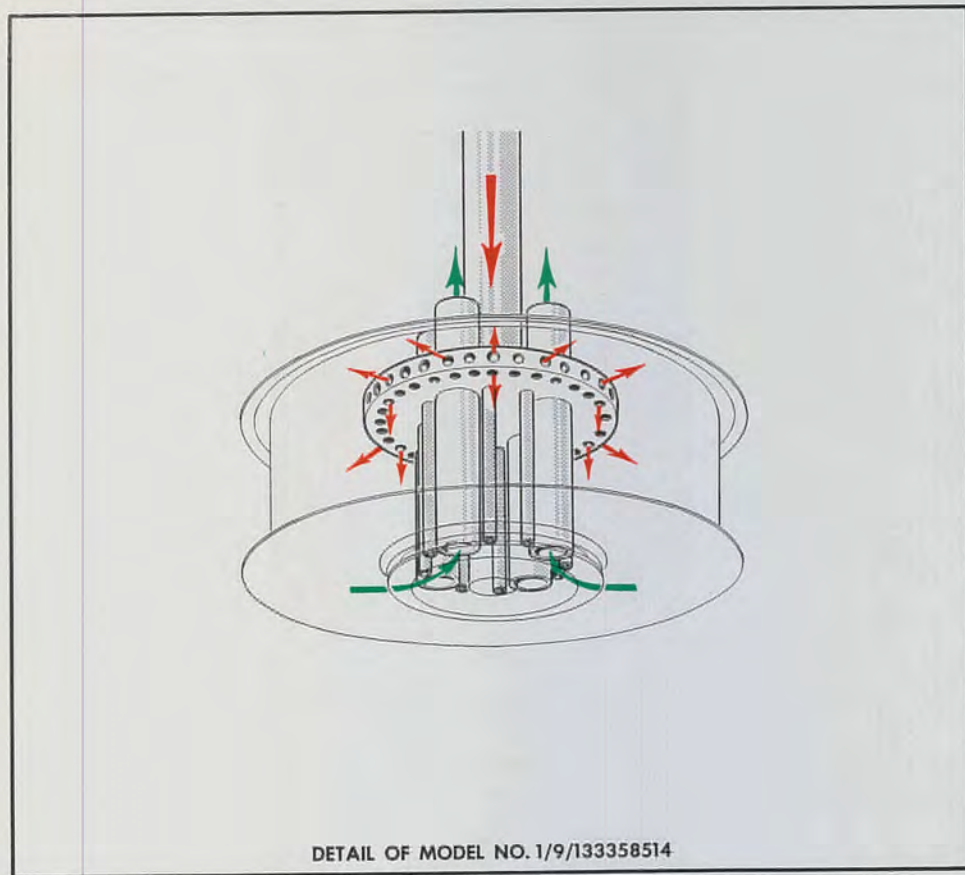


1224-179

FIG. 42

AIR CUSHION EFFECTS MODEL NO. 1/9

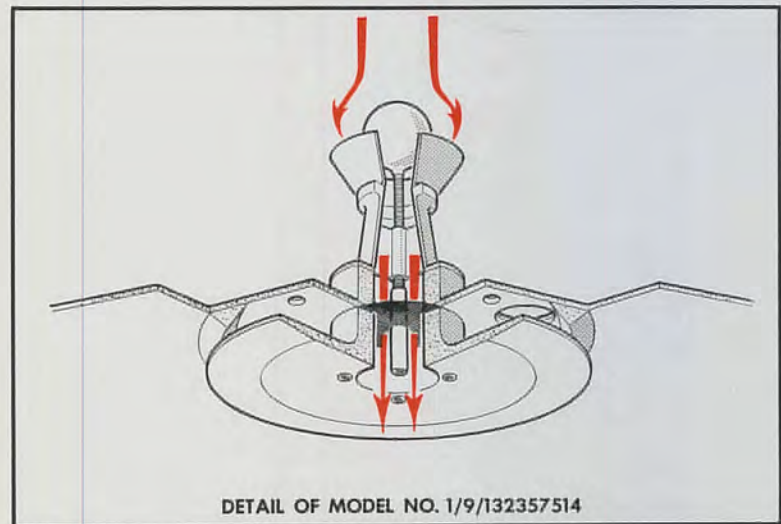
RIG DRWG. NO. SK 21295 SHT. 1
MODEL DRWG. NO. 17 SK 30226
27 SK 30038
20" DIA. MODEL



DETAIL OF MODEL NO. 1/9/133358514

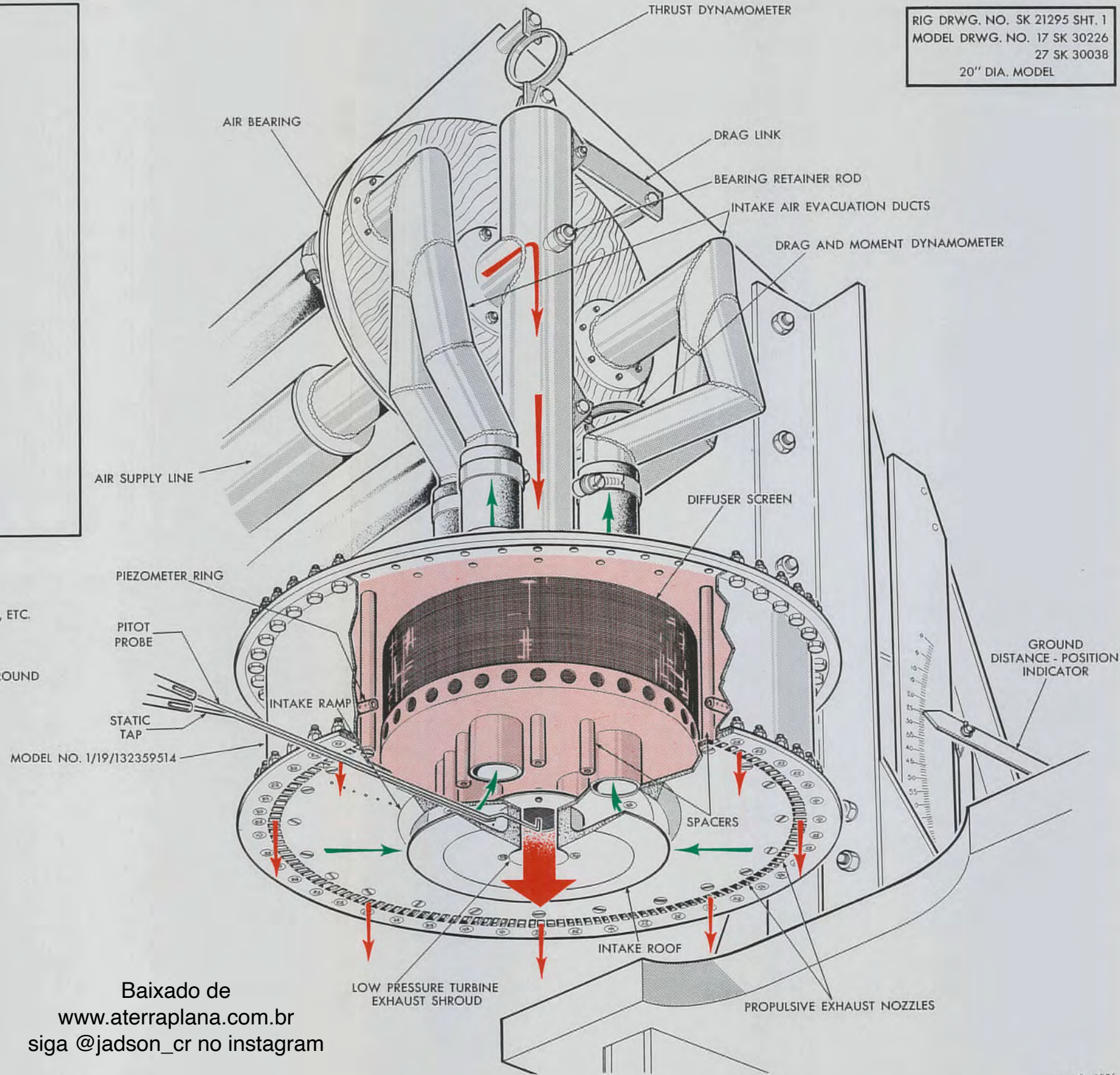
NOTE:

- 1. THIS IS SHEET NO. 5 FOR OTHER ILLUSTRATIONS REFER TO SHEETS NO. 1, 2, 3, ETC. FOR OTHER CONFIGURATIONS REFER TO TABLE
- 2. FOR PYLON PITOT REFERENCE PROBE AND TAP, AND ALSO THE ARTIFICIAL GROUND REFER TO ILLUSTRATION OF RIG



DETAIL OF MODEL NO. 1/9/132357514

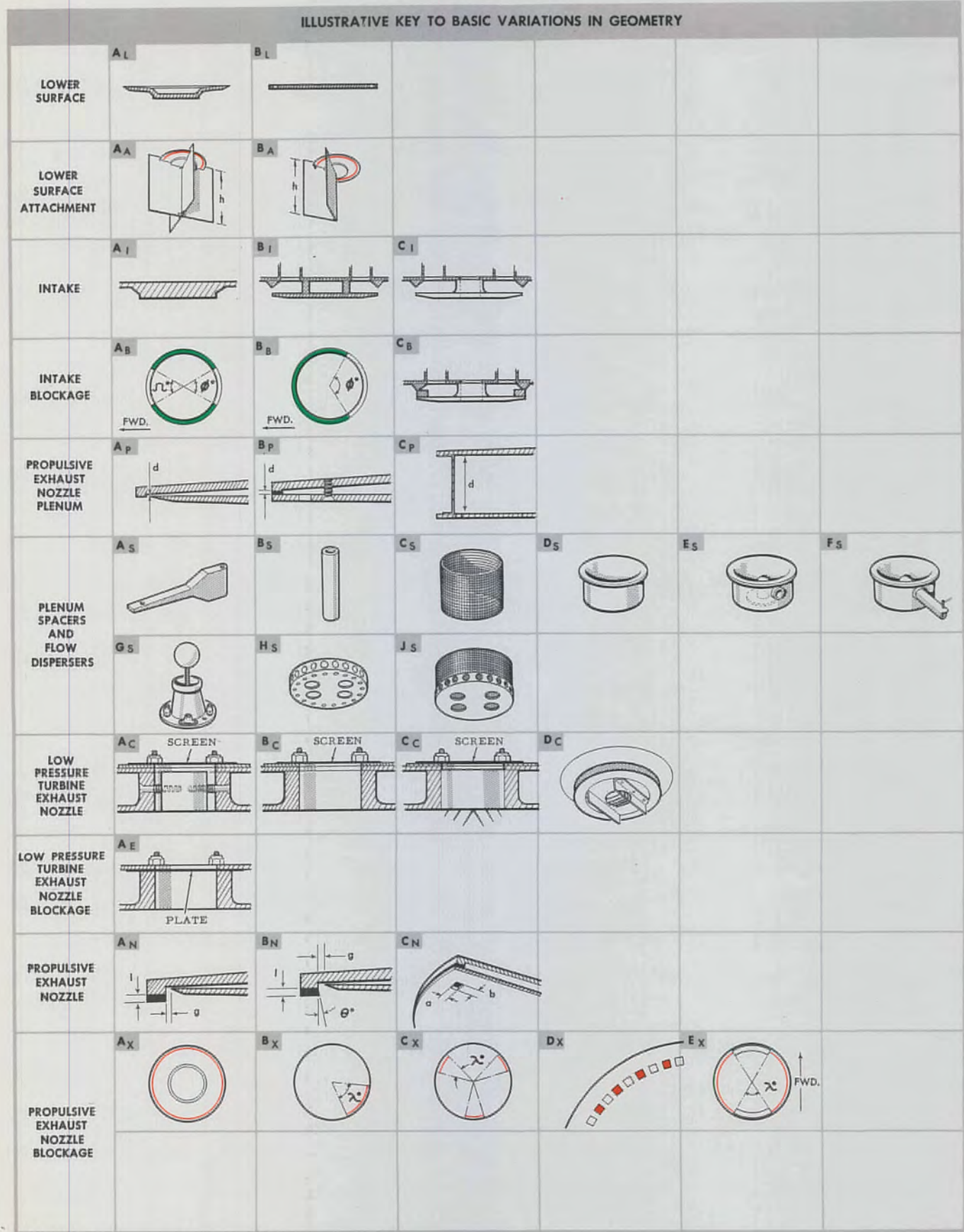
1664-1794-1



MODEL NO. 1/19/132359514

Baixado de
www.aterraplana.com.br
siga @jadson_cr no instagram

June 8, 1956.

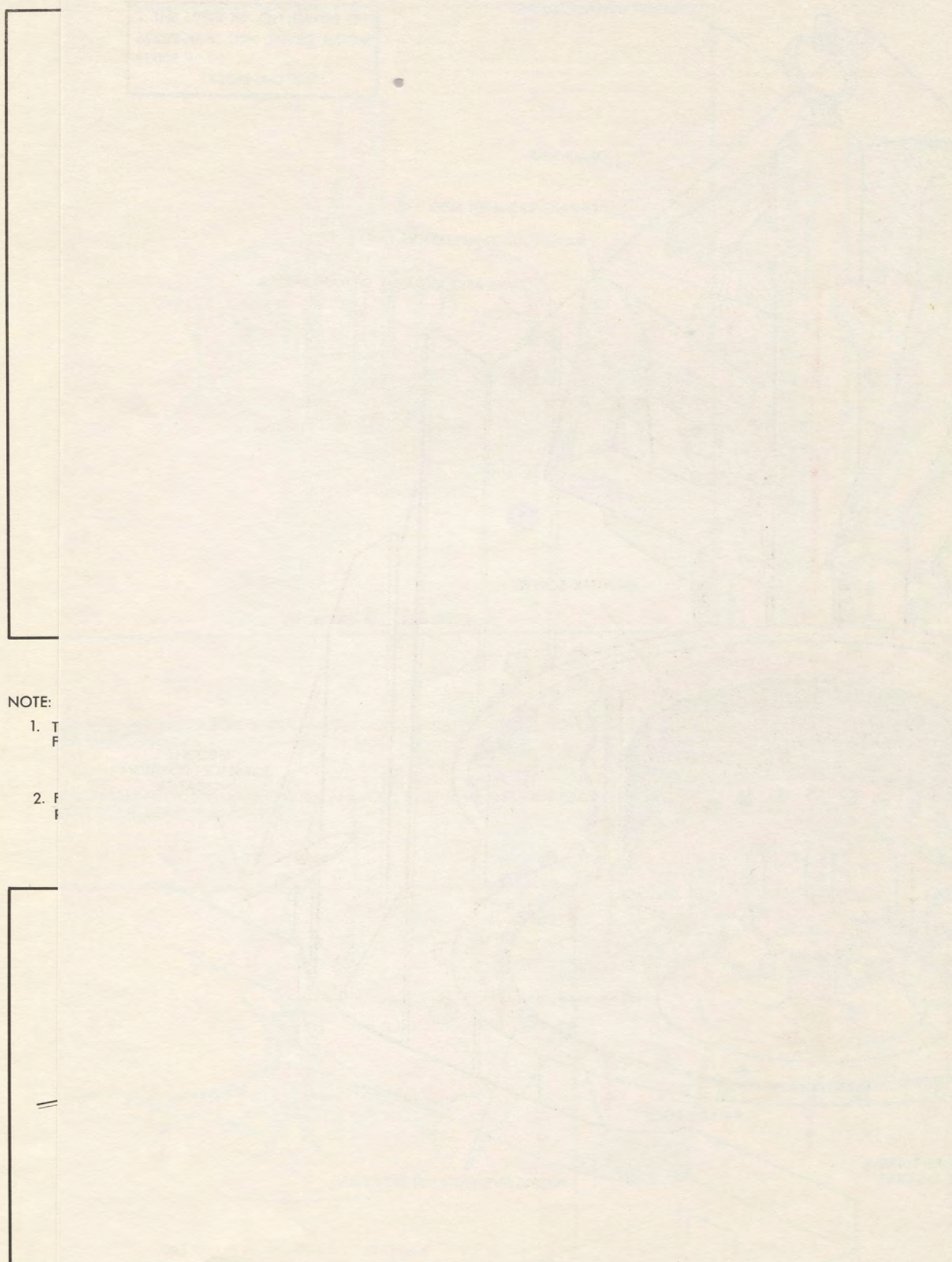


MODEL NO.	6" PYLON EXTENSION		LOWER SURFACE	LOWER SURFACE ATTACHMENT		INTAKE	INTAKE BLOCKAGE			PROPULSIVE EXHAUST NOZZLE PLENUM		SPACERS AND FLOW DISPERSERS		LOW PRESSURE TURBINE EXHAUST NOZZLE			L. P. T. EXHAUST NOZZLE BLOCKAGE	PROPULSIVE EXHAUST NOZZLE					PROPULSIVE EXHAUST NOZZLE BLOCKAGE				
	IN	OUT		TYPE	DIM "h"		TYPE	ϕ	ω	TYPE	DIM "d"	TYPE	NO. OF BAFFLES	TYPE OF SCREEN	TYPE	l		g	θ°	a	b	TYPE	ANGLE λ°				
1/9/121122211		OUT	A_L	A_A	SEE ILLUS	A_I				A_P	.110"	B_S								A_N	.091	.037				A_X	
211112111	IN		A_L			A_I				A_P	.050"	B_S								A_N		.037				A_X	
211111211	IN		A_L			A_I				A_P	.050"	A_S								A_N	.091	.037				A_X	
211112211	IN		A_L			A_I				A_P	.050"	B_S								A_N	.091	.037				A_X	
211112212	IN		A_L			A_I				A_P	.050"	B_S								A_N	.091	.060				A_X	
211111212	IN		A_L			A_I				A_P	.050"	A_S								A_N	.091	.060				A_X	
211112213	IN		A_L			A_I				A_P	.050"	B_S								A_N	.091	.100				A_X	
211122213	IN		A_L			A_I				A_P	.110"	B_S								A_N	.091	.100				A_X	
211122223	IN		A_L			A_I				A_P	.110"	B_S								A_N	.091	.100				B_X	60°
211122313	IN		A_L			A_I				A_P	.110"	B_S								A_N	.250	.100				A_X	
211122413	IN		A_L			A_I				A_P	.110"	B_S								B_N	.250	.100	10°			A_X	
211122233	IN		A_L			A_I				A_P	.110"	B_S								A_N	.091	.100				C_X	20°
211122243	IN		A_L			A_I				A_P	.110"	B_S								A_N	.091	.100				C_X	40°
211122253	IN		A_L			A_I				A_P	.110"	B_S								A_N	.091	.100				C_X	60°
211122263	IN		A_L			A_I				A_P	.110"	B_S								A_N	.091	.100				C_X	80°
211122273	IN		A_L			A_I				A_P	.110"	B_S								A_N	.091	.100				C_X	100°
232132514	IN		B_L			B_I				B_P	.341"	B_S								C_N				.320"	.405"	A_X	
233132514	IN		B_L			B_I	C_B			B_P	.341"	B_S								C_N				.320"	.405"	A_X	
233142514	IN		B_L			B_I	C_B			B_P	.682"	B_S								C_N				.320"	.405"	A_X	
233152514	IN		B_L			B_I	C_B			C_P	6.0"	B_S								C_N				.320"	.405"	A_X	
133153514	OUT		B_L			B_I	C_B			C_P	6.0"	B_S, C_S								C_N				.320"	.405"	A_X	
133154514	OUT		B_L			B_I	C_B			C_P	6.0"	B_S, D_S								C_N				.320"	.405"	A_X	
133154534	OUT		B_L			B_I	C_B			C_P	6.0"	B_S, D_S								C_N				.320"	.405"	C_X	60°
133154524	OUT		B_L			B_I	C_B			C_P	6.0"	B_S, D_S								C_N				.320"	.405"	C_X	30°
132254514	OUT		B_L			C_I				C_P	6.0"	B_S, D	A_C	FINE						C_N				.320"	.405"	A_X	
133254514	OUT		B_L			C_I	C_B			C_P	6.0"	B_S, D_S	A_C	FINE						C_N				.320"	.405"	A_X	
133155514	OUT		B_L			C_I	C_B			C_P	6.0"	B_S, F_S						A_E		C_N				.320"	.405"	A_X	
133155554	OUT		B_L			C_I	C_B			C_P	6.0"	B_S, F_S						A_E		C_N				.320"	.405"	D_X	
132155514	OUT		B_L			C_I				C_P	6.0"	B_S, F_S						A_E		C_N				.320"	.405"	A_X	
132355514	OUT		B_L			C_I				C_P	6.0"	B_S, F_S	B_C	MEDIUM						C_N				.320"	.405"	A_X	
133355514	OUT		B_L			C_I	C_B			C_P	6.0"	B_S, F_S	B_C	MEDIUM						C_N				.320"	.405"	A_X	
132455514	OUT		B_L			C_I				C_P	6.0"	B_S, F_S	C_C	MEDIUM						C_N				.320"	.405"	A_X	
135455564	OUT		B_L			C_I	A_B	30°	30°	C_P	6.0"	B_S, F_S	C_C	MEDIUM						C_N				.320"	.405"	E_X	19.1°
135455514	OUT		B_L			C_I	A_B	30°	30°	C_P	6.0"	B_S, F_S	C_C	MEDIUM						C_N				.320"	.405"	A_X	
144555514	OUT		B_L			C_I	B_B	60°		C_P	6.0"	B_S, F_S	D_C	2	MEDIUM					C_N				.320"	.405"	A_X	
134555514	OUT		B_L			C_I	B_B	60°		C_P	6.0"	B_S, F_S	D_C	NONE	MEDIUM					C_N				.320"	.405"	A_X	
133156514	OUT		B_L			C_I	C_B			C_P	6.0"	B_S, E_S							A_E	C_N				.320"	.405"	A_X	
132156514	OUT		B_L			C_I				C_P	6.0"	B_S, E_S							A_E	C_N				.320"	.405"	A_X	
132356514	OUT		B_L			C_I				C_P	6.0"	B_S, E_S	B_C	MEDIUM						C_N				.320"	.405"	A_X	
133356514	OUT		B_L			C_I	C_B			C_P	6.0"	B_S, E_S	B_C	MEDIUM						C_N				.320"	.405"	A_X	
133156534	OUT		B_L			C_I	C_B			C_P	6.0"	B_S, E_S							A_E	C_N				.320"	.405"	C_X	60°
133156524	OUT		B_L			C_I	C_B			C_P	6.0"	B_S, E_S							A_E	C_N				.320"	.405"	C_X	30°
133157514	OUT		B_L			C_I	C_B			C_P	6.0"	B_S, D_S, G_S							A_E	C_N				.320"	.405"	A_X	
132157514	OUT		B_L			C_I				C_P	6.0"	B_S, D_S, G_S							A_E	C_N				.320"	.405"	A_X	
132357514	OUT		B_L			C_I				C_P	6.0"	B_S, D_S, G_S	B_C	MEDIUM						C_N				.320"	.405"	A_X	
133357514	OUT		B_L			C_I	C_B			C_P	6.0"	B_S, D_S, G_S	B_C	MEDIUM						C_N				.320"	.405"	A_X	
133157524	OUT		B_L			C_I	C_B			C_P	6.0"	B_S, D_S, G_S							A_E	C_N				.320"	.405"	C_X	30°
133158514	OUT		B_L			C_I	C_B			C_P	6.0"	B_S, H_S							A_E	C_N				.320"	.405"	A_X	

1613-1794-1a

June 8, 1956.

MODEL NO. 1/9 AND 1/10 - CONFIGURATIONS TESTED - TABLE 1



NOTE:

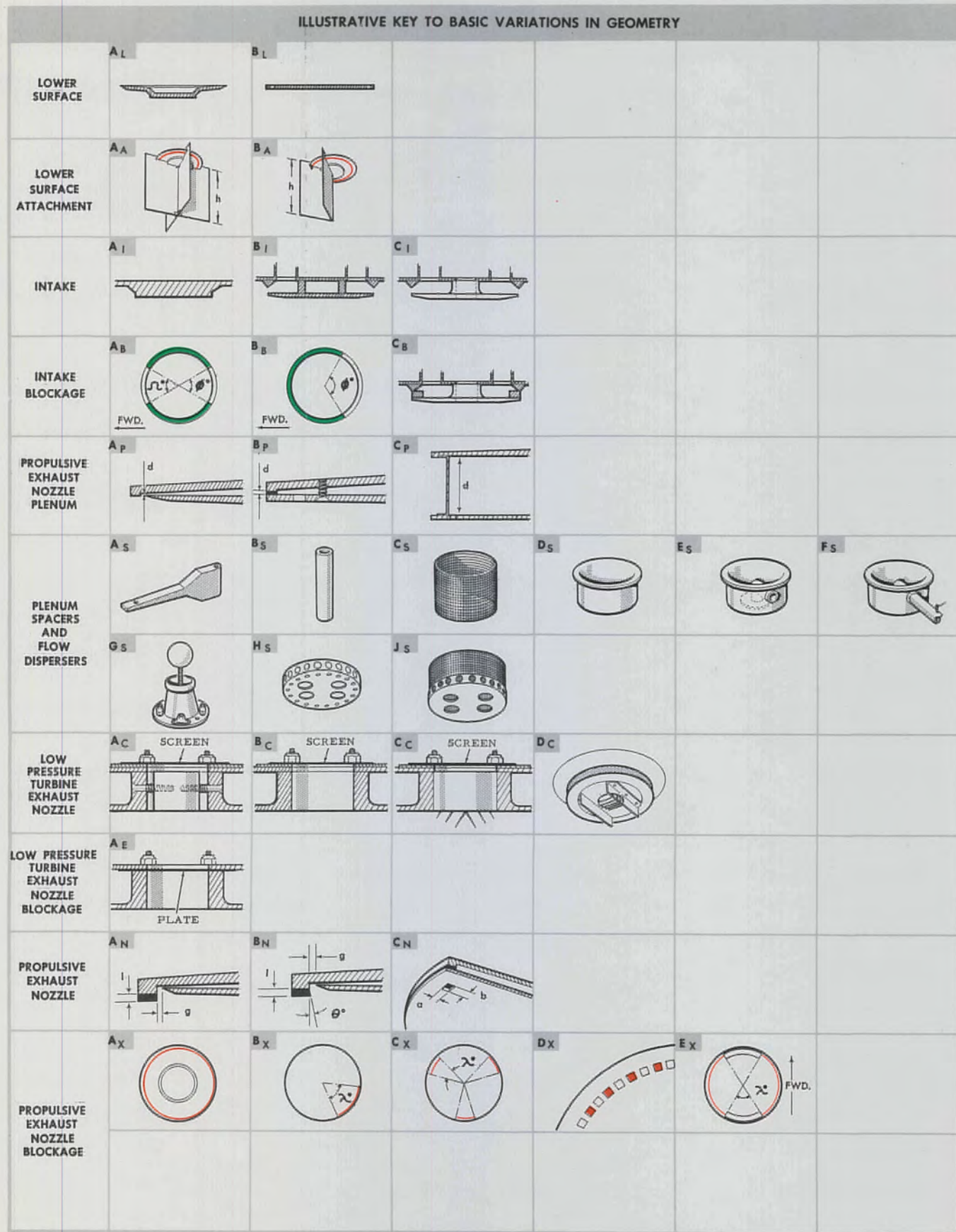
1. T
F

2. F
F

1664-17

FIG. 43

AIR CUSHION EFFECTS MODEL NUMBER 1/9 (CONTINUED)



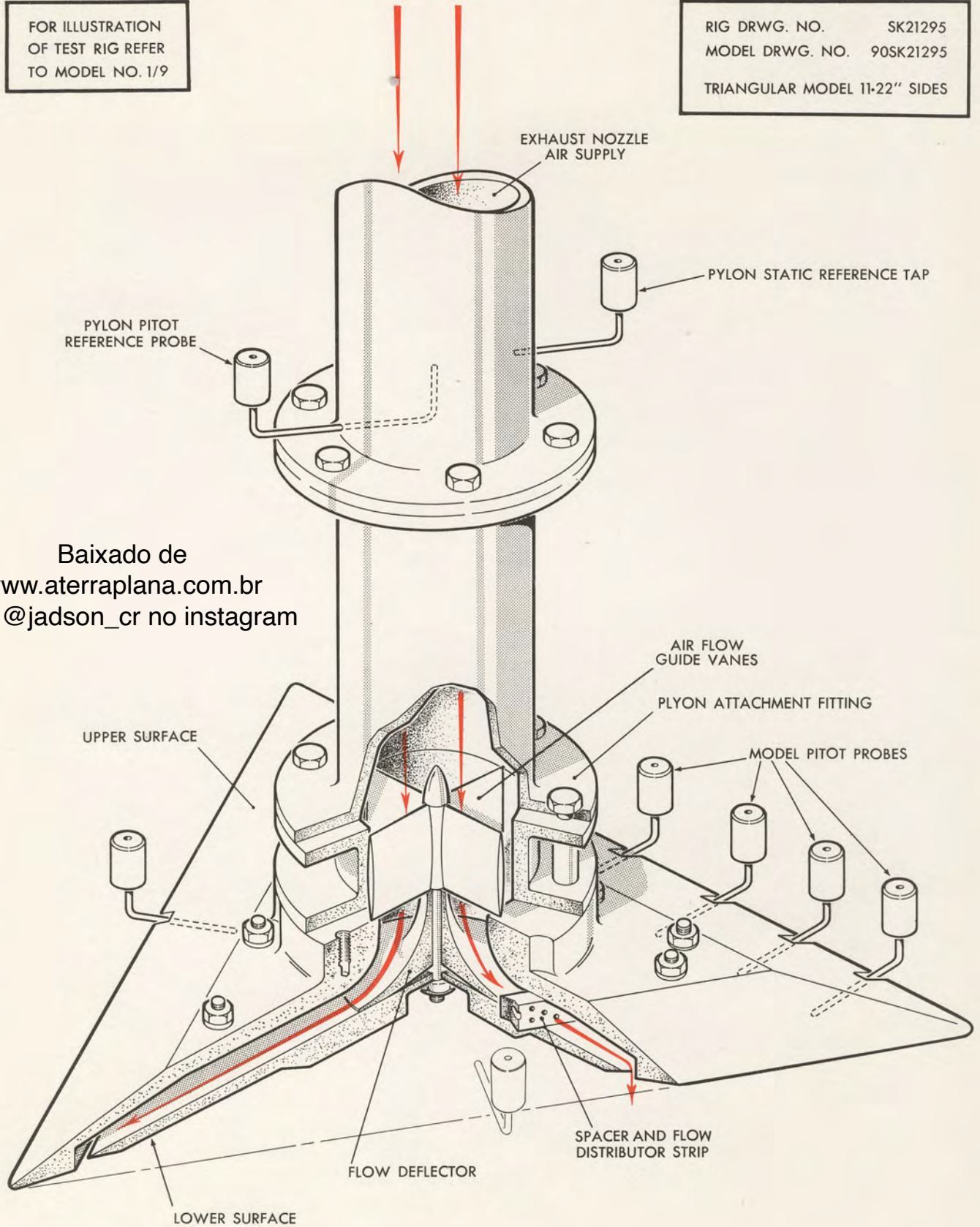
MODEL NO.	6" PYLON EXTENSION		LOWER SURFACE	LOWER SURFACE ATTACHMENT		INTAKE	INTAKE BLOCKAGE			PROPULSIVE EXHAUST NOZZLE PLENUM		SPACERS AND FLOW DISPERSERS		LOW PRESSURE TURBINE EXHAUST NOZZLE			L.P.T. EXHAUST NOZZLE BLOCKAGE					PROPULSIVE EXHAUST NOZZLE					PROPULSIVE EXHAUST NOZZLE BLOCKAGE	
	IN	OUT		TYPE	DIM "h"		TYPE	∅°	Ω°	TYPE	DIM "d"	TYPE	NO. OF BAFFLES	TYPE OF SCREEN	TYPE	NO. OF BAFFLES	TYPE OF SCREEN	TYPE	l	g	θ°	a	b	TYPE	ANGLE X			
1/9/132158514		OUT	B_L			C_I				C_P	6.0"	B_S, H_S				A_E	C_N				.320"	.405"	A_X					
132358514		OUT	B_L			C_I				C_P	6.0"	B_S, H_S	B_C		MEDIUM		C_N				.320"	.405"	A_X					
133358514		OUT	B_L			C_I	C_B			C_P	6.0"	B_S, H_S	B_C		MEDIUM		C_N				.320"	.405"	A_X					
133158524		OUT	B_L			C_I	C_B			C_P	6.0"	B_S, H_S				A_E	C_N				.320"	.405"	C_X	30°				
133158534		OUT	B_L			C_I	C_B			C_P	6.0"	B_S, H_S				A_E	C_N				.320"	.405"	C_X	60°				
133159514		OUT	B_L			C_I	C_B			C_P	6.0"	B_S, J_S				A_E	C_N				.320"	.405"	A_X					
132159514		OUT	B_L			C_I				C_P	6.0"	B_S, J_S				A_E	C_N				.320"	.405"	A_X					
132359514		OUT	B_L			C_I				C_P	6.0"	B_S, J_S	B_C		MEDIUM		C_N				.320"	.405"	A_X					
133359514		OUT	B_L			C_I	C_B			C_P	6.0"	B_S, J_S	B_C		MEDIUM		C_N				.320"	.405"	A_X					
133159524		OUT	B_L			C_I	C_B			C_P	6.0"	B_S, J_S				A_E	C_N				.320"	.405"	C_X	30°				
133159534		OUT	B_L			C_I	C_B			C_P	6.0"	B_S, J_S				A_E	C_N				.320"	.405"	C_X	60°				
1/10/12211		OUT	A_L	B_A		A_I				A_P	.050"	B_S				A_N	.091	.037					A_X					

MODEL NO. 1/9 AND 1/10 - CONFIGURATIONS TESTED - TABLE 1 (CON'T)

FOR ILLUSTRATION
OF TEST RIG REFER
TO MODEL NO. 1/9

RIG DRWG. NO. SK21295
MODEL DRWG. NO. 90SK21295
TRIANGULAR MODEL 11-22" SIDES

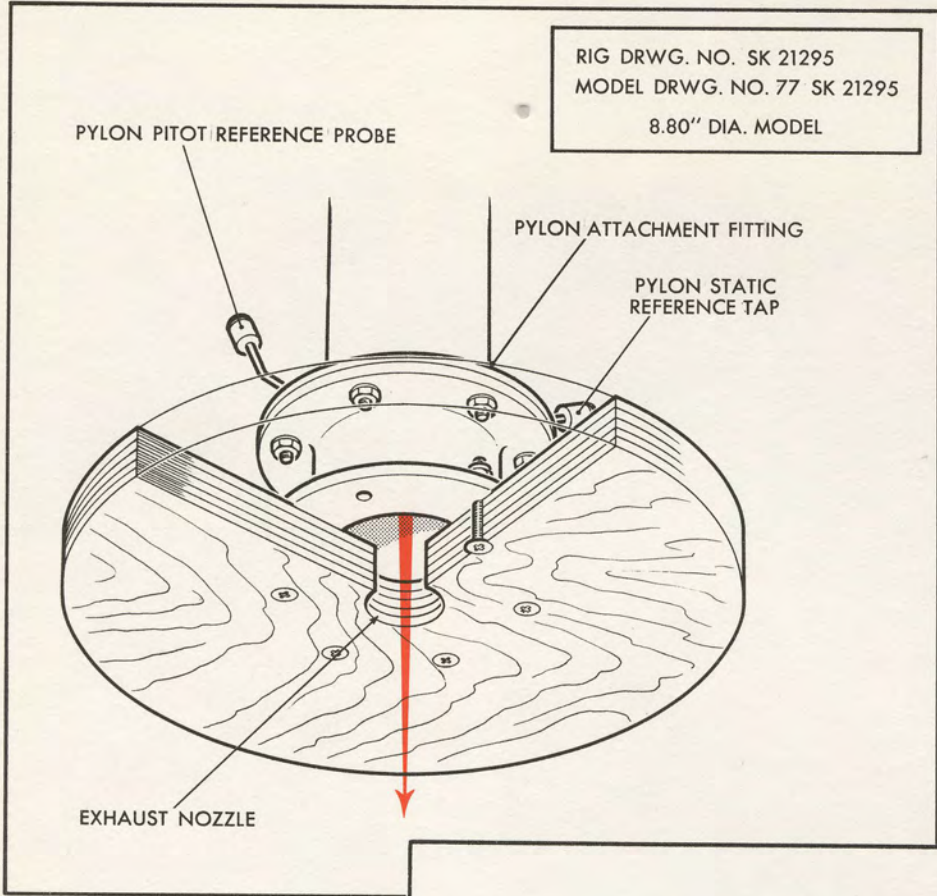
Baixado de
www.aterraplana.com.br
siga @jadson_cr no instagram



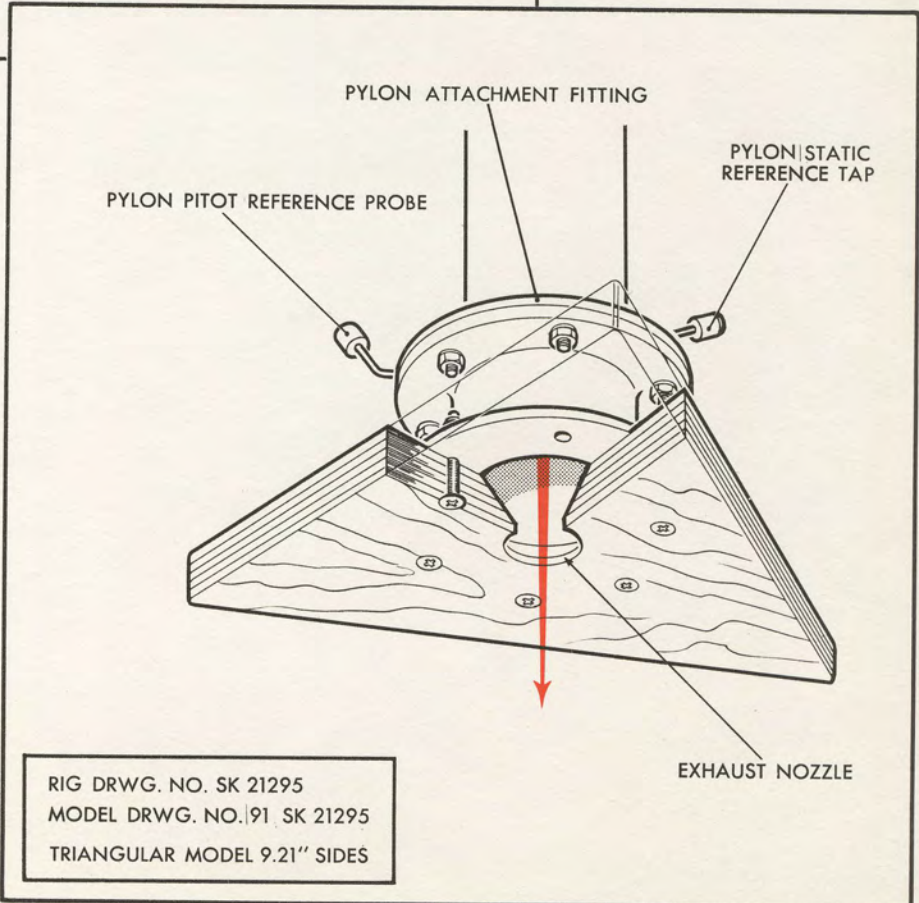
1565-1794-2

MAY 3, 1956

FIG. 44
AIR CUSHION EFFECTS MODEL NO. 1/26/1



MODEL NO. 1/12/1



MODEL NO. 1/13/1

1226-1794-1

APRIL 25 - 1956

FIG. 45 AIR CUSHION EFFECTS MODELS NO. 1/12 AND 1/13

5.1.2
(Cont'd)

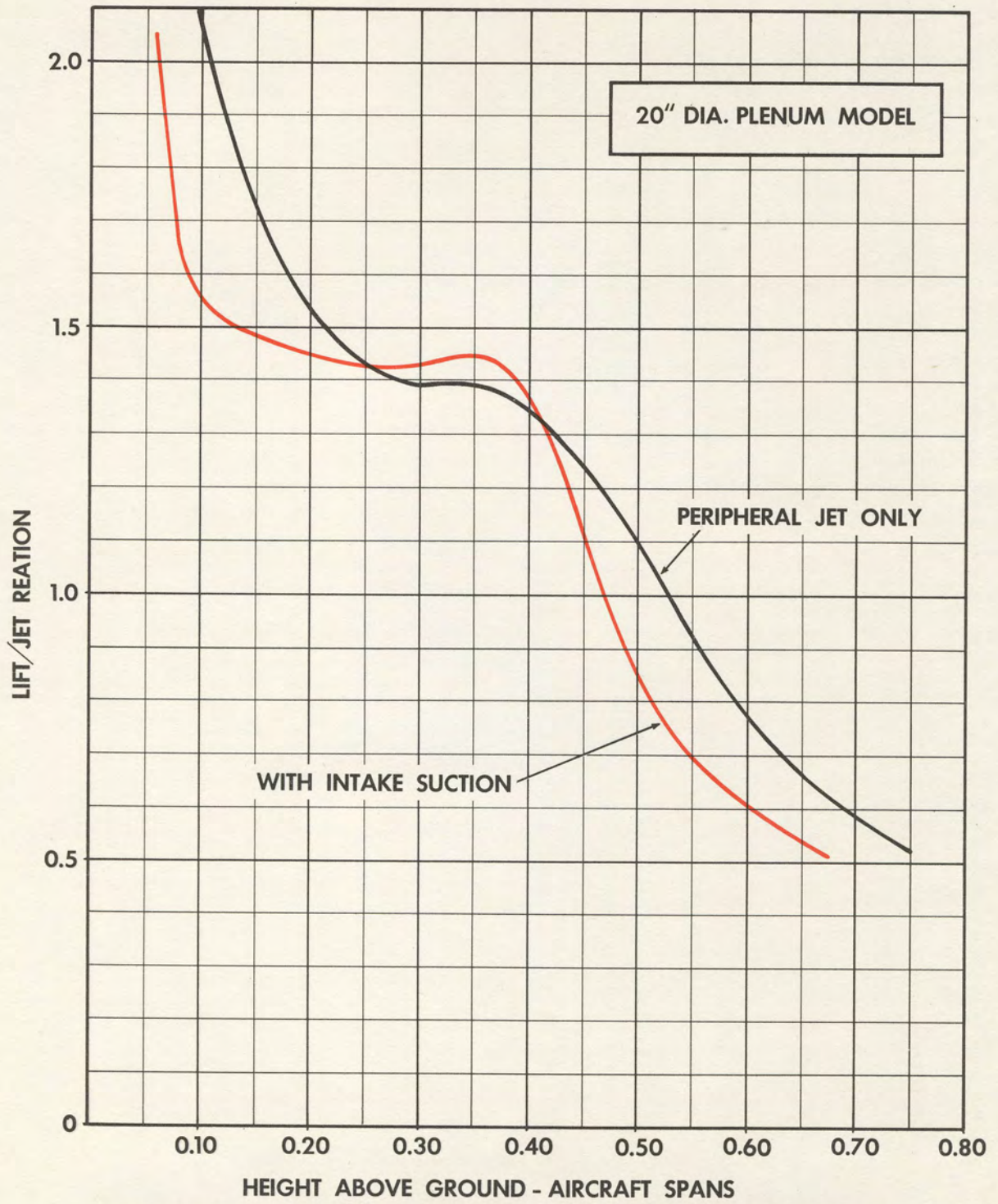
that have been carried out are listed in Fig. 41 and on Pages 59 and 60.

Broad conclusions are as follows:

- (i) There was very little change in the ground cushion due to the change in scale.
- (ii) The lift augmentation extends at a high level to between 45 and 60 percent of the span, as much as 1.8 times the jet thrust has been recorded at 45 percent span from the ground. After this it falls off rapidly to between 50 and 60 percent of the jet thrust in free air. The free air thrust can be restored by shutting off the jet over local arcs around the perimeter.
- (iii) The air cushion is found to be affected by the following:
 - (a) The angle the jet leaves the nozzle
 - (b) The jet aspect ratio (circumference/width)
 - (c) The lower surface air intake
 - (d) The lower surface central exhaust (from the power turbine)
 - (e) The shape of the lower surface
 - (f) The distance apart of the exhaust nozzles

It has not been found that moderate changes in any of these parameters makes a drastic alteration in the general air cushion characteristic, although the detail effects have been quite considerable.

The design of the aircraft to some extent prejudices the achievement of the optimum ground cushion effect. Fig. 46, showing the



PROJECT 1794 EFFECT OF LOWER INTAKE SUCTION ON GROUND CUSHION EFFECT

FIG. 46

5.1.2
(Cont'd)

difference due to the lower surface air intake is regarded as typical. Difficulties have been encountered in achieving complete similarity to full scale in these tests, principally those of matching the three flows on the lower surfaces - the air intake, the peripheral jet and the central exhaust - and of obtaining a representative flow into the air intake. Further tests are therefore necessary so that the exact ground cushion effect for the configuration with full air intake, hot central exhaust and exact aircraft nozzle geometry can be obtained.

5.1.3 Stability and Control Tests: Tests relating to the stability and control area involved the collection of aerodynamic and control data from wind tunnel tests and have been noted in 5.1.1.

Further tests on these wind tunnel models have also been suggested in that section. In addition the following tests are considered necessary:

- (i) Transonic aerodynamic and control data is required; for which a new force model with provision for air intake and exhaust jet flow simulation is needed.
- (ii) Rig tests to determine the behaviour of the pneumatic system and shutters, particularly the speed of response, are required. A simple rig containing one pair of nozzles has already been constructed (Fig. 47) and this will be used to obtain response data and to develop the shutter control. The final stage is

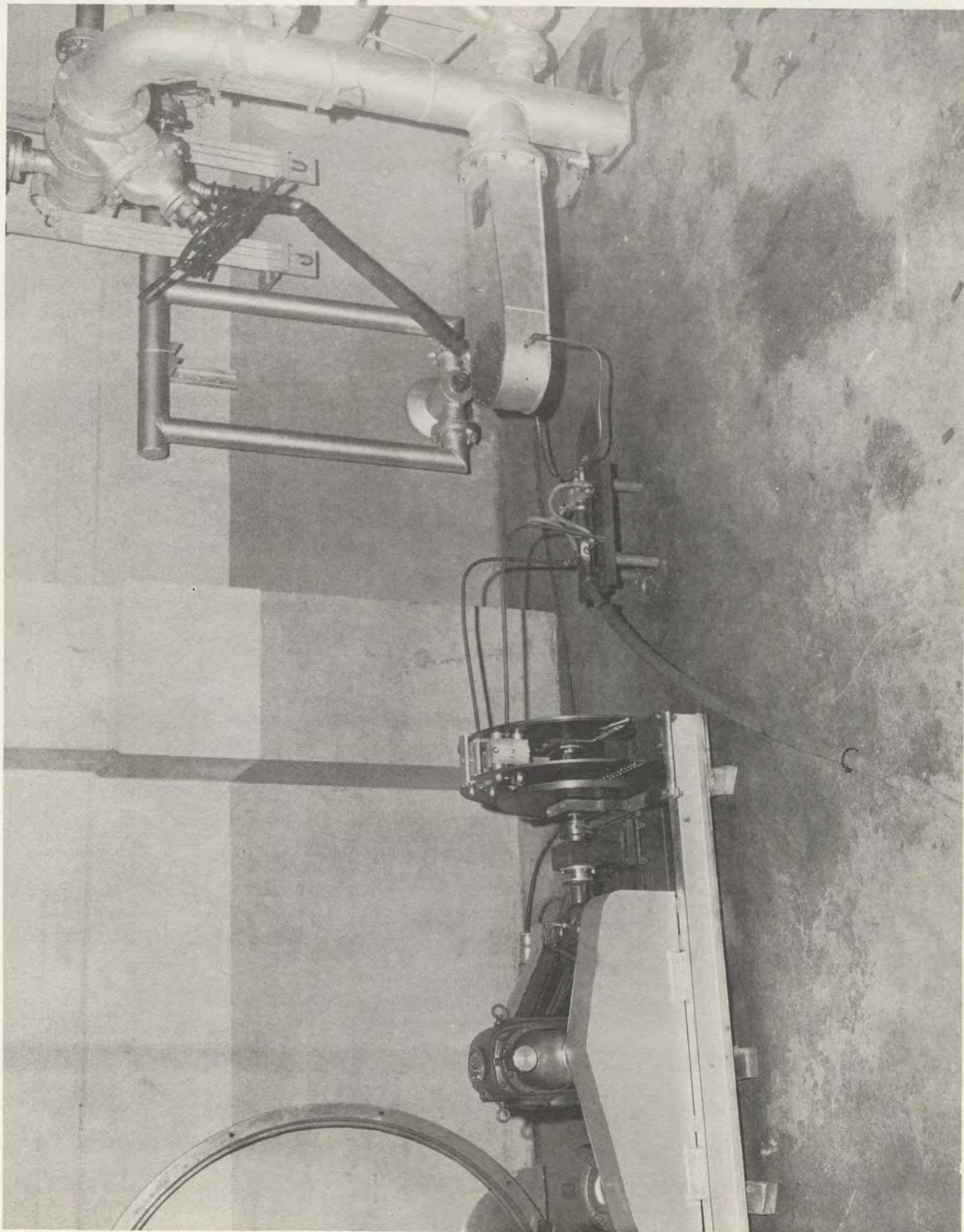


FIG. 47 SHUTTER TEST & OSCILLATION RIG

5.1.3
(Cont'd)

foreseen as a peripheral segment attached to the main central test piece the contractor is planning which is briefly described in section 8.

- NOTE: It is pointed out that the work statement for the contract calls for six component aerodynamic data. However, in view of the extreme difficulty of engineering a six component special balance with provision for intake and jet flow simulation, the models tested were designed and approved for the measurement of lift, drag and pitching moment only. Measurement of side force, rolling and yawing moments is considered secondary: particularly for this design because of the symmetrical shape.

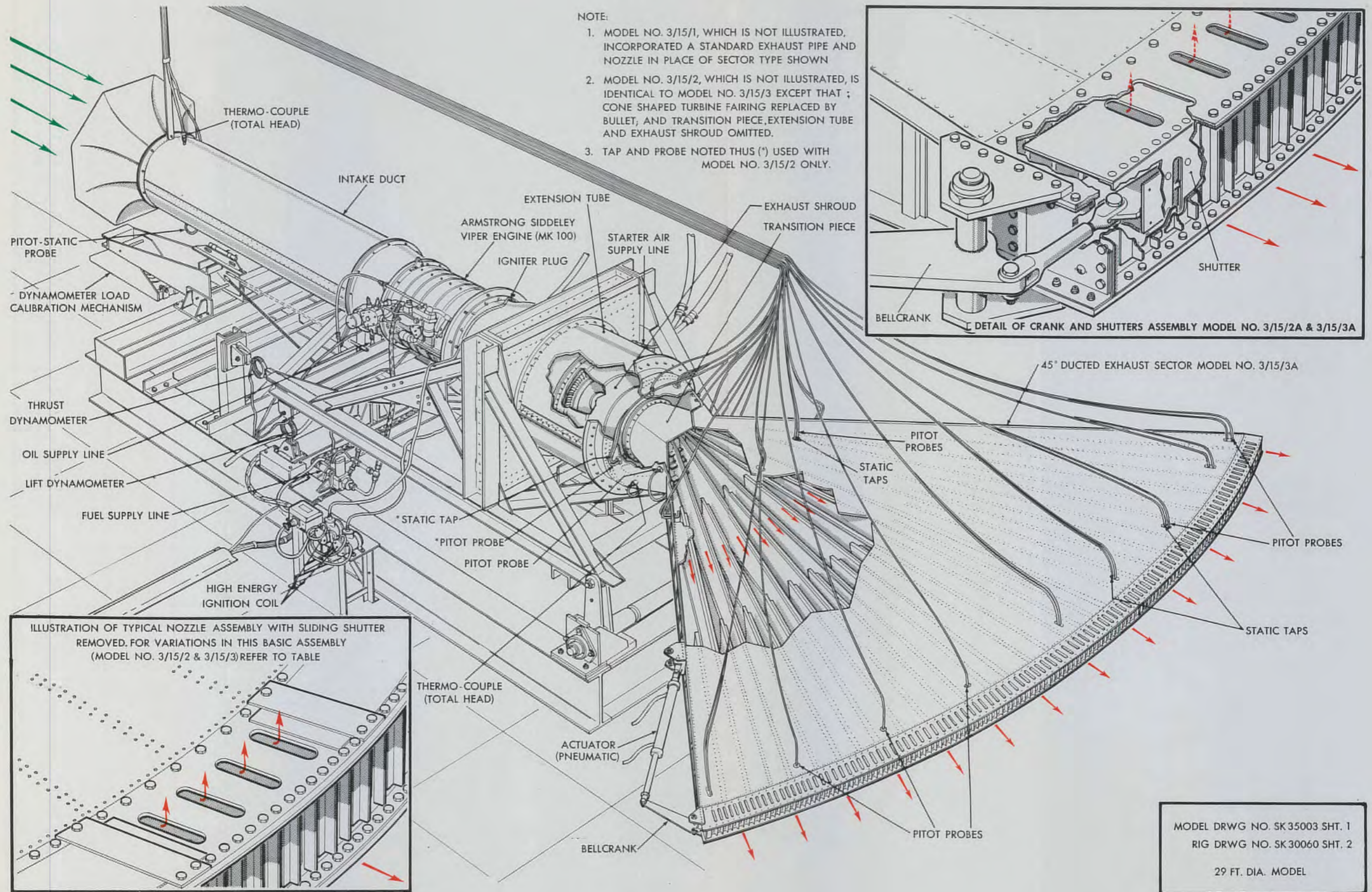
5.1.4 Air Intake and Gas Exhaust System Test: Two of the models previously referred to in 5.1.1 are concerned with the air intake. With regard to the exhaust system, several tests have been done, as follows:

5.1.4.1 45° Full Scale Segment Test - A segment of the proposed intermediate research aircraft of Fig. 2 (Page 5) was constructed and mounted on a thrust and moment balance with instrumentation for pressure and temperature measurement. (Figs. 48 and 49).

The objectives for this test piece were to obtain -

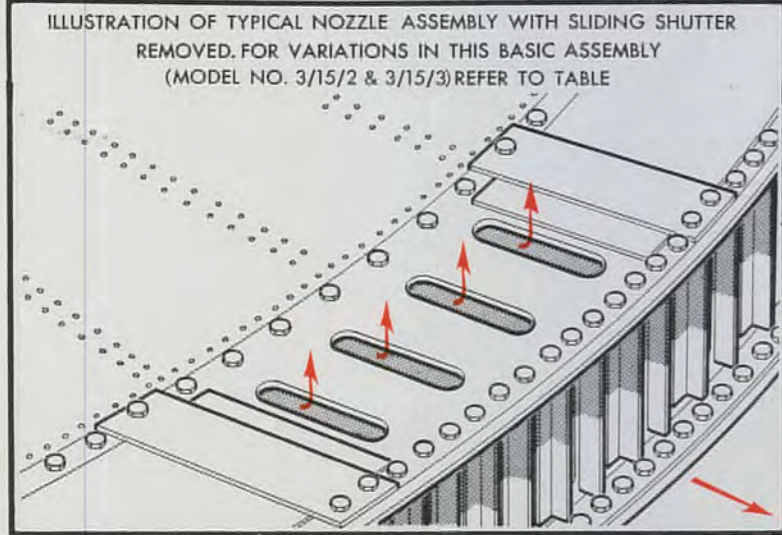
- (i) A 45° segment full scale air cushion effect test.
- (ii) Hot jet duct behaviour.

~~SECRET~~



NOTE:

1. MODEL NO. 3/15/1, WHICH IS NOT ILLUSTRATED, INCORPORATED A STANDARD EXHAUST PIPE AND NOZZLE IN PLACE OF SECTOR TYPE SHOWN
2. MODEL NO. 3/15/2, WHICH IS NOT ILLUSTRATED, IS IDENTICAL TO MODEL NO. 3/15/3 EXCEPT THAT ; CONE SHAPED TURBINE FAIRING REPLACED BY BULLET, AND TRANSITION PIECE, EXTENSION TUBE AND EXHAUST SHROUD OMITTED.
3. TAP AND PROBE NOTED THUS (*) USED WITH MODEL NO. 3/15/2 ONLY.



MODEL DRWG NO. SK 35003 SHT. 1
 RIG DRWG NO. SK 30060 SHT. 2
 29 FT. DIA. MODEL

1245-1794-2

Revised June 1, 1956

AIR INTAKE AND GAS EXHAUST SYSTEM MODEL NO. 3/15

~~SECRET~~



PITOT-S
PROI

DYNA
CALIBRA

THR
DYNAM

OIL S
LIFT



1245-179



FIG. 48

AIR INTAKE AND GAS EXHAUST SYSTEM MODEL NO. 3/15

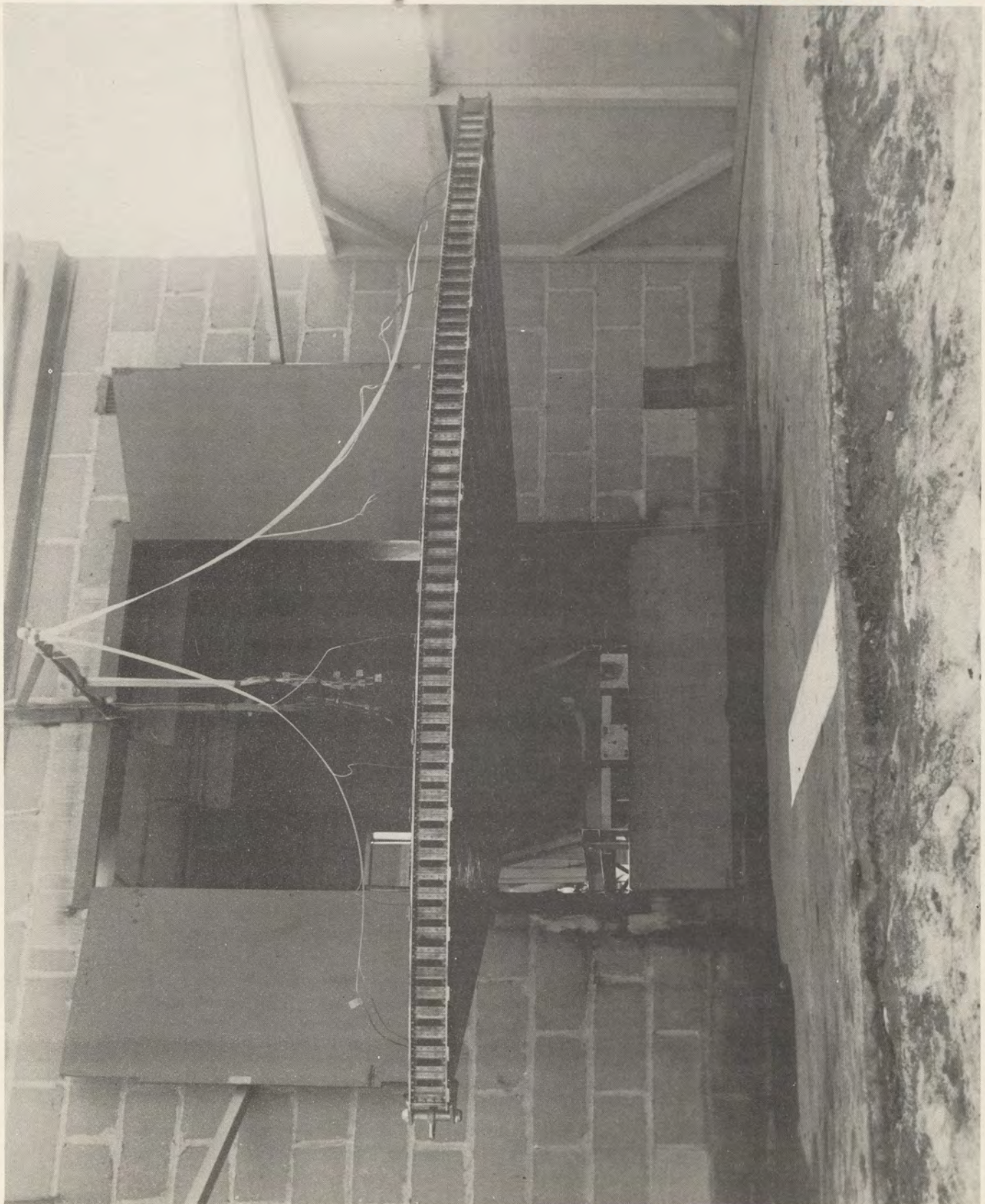


FIG. 49 45° SEGMENT

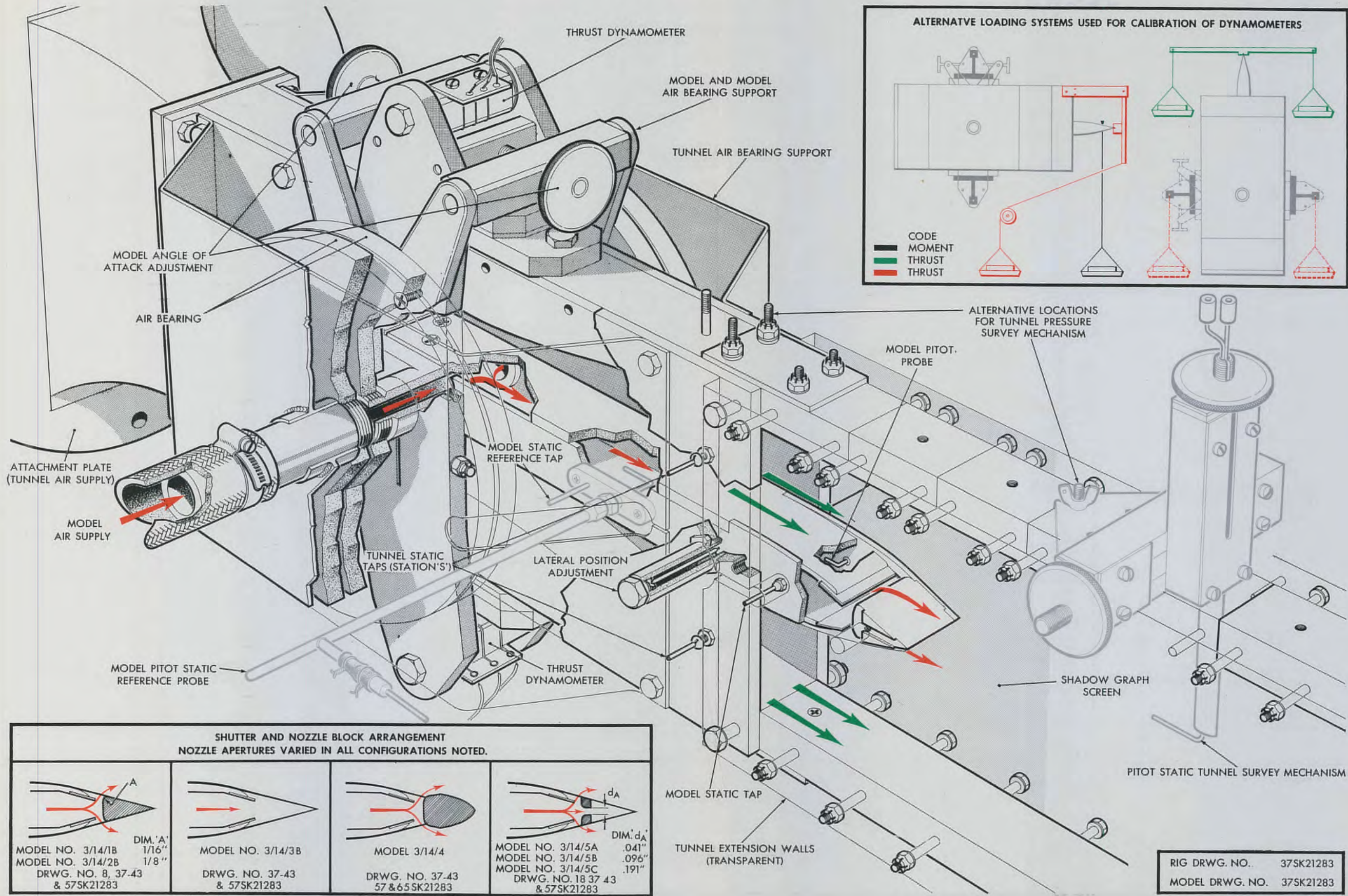
5.1.4.1
(Cont'd)

- (iii) Diffuser efficiency.
- (iv) Flow and temperature distribution.
- (v) Ground temperatures.
- (vi) Control operation data.

This segment was completed before the ducted fan concept had rendered its design obsolete. It was then also found from small scale tests that the air cushion effect characteristic was drastically altered for a 45° segment so that its usefulness for full scale air cushion test also appeared marginal and in view of the 1/6th scale wind tunnel model being available for ground cushion this was discontinued.

An abbreviated series of tests were, however, run on this segment to determine its diffuser efficiency. Two series were run, the first being vitiated by failure of the specimen. A re-run after repair yielded the general conclusion that the diffuser pressure drop was not measurable with the local instrumentation provided and is probably unimportant.

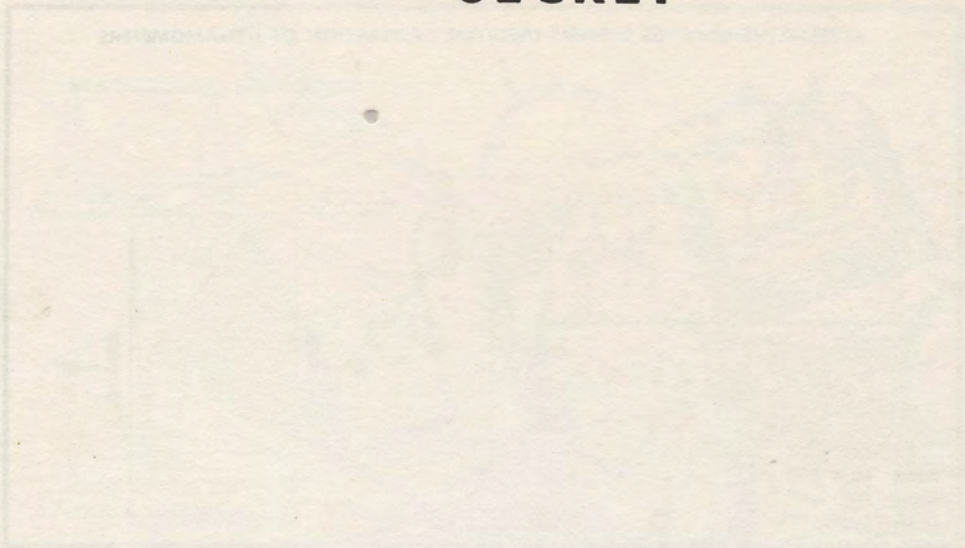
5.1.4.2 Thrust Recovery Test - Tests were carried out on a two dimensional flow model (Figs. 50 and 51) exhausting substantially at right angles to a supersonic stream to see how much of the thrust of such a nozzle was recovered in the stream direction. These tests were originally applicable to the propulsion nozzle scheme for the aircraft of Fig. 1 (Page 4) but have a general interest and



1242-1794-1

AIR INTAKE AND GAS EXHAUST SYSTEM MODEL NO. 3/14/1B, 3/14/2B, 3/14/3B, 3/14/4 AND 3/14/5

~~SECRET~~



ATTN
(TUNING)

MO
MO

1242-

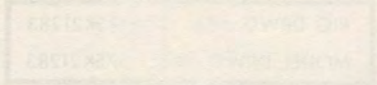
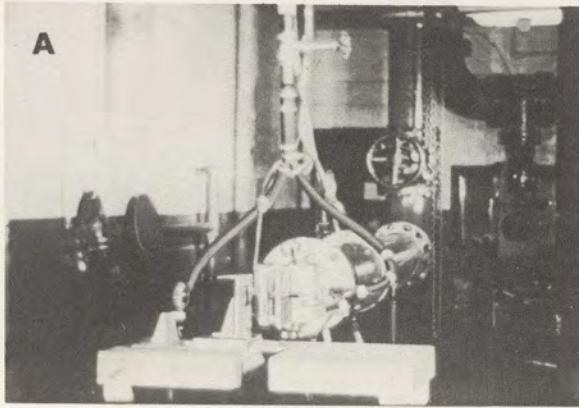


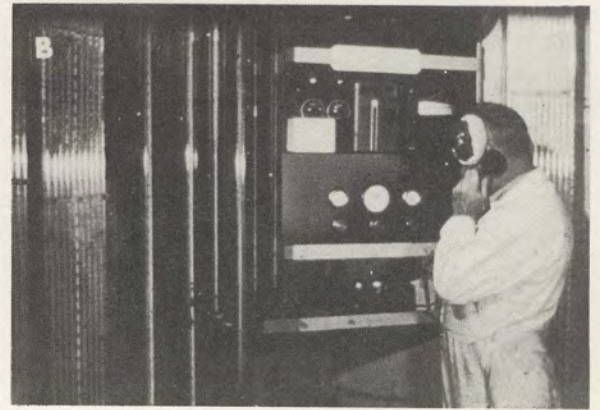
FIG. 50

AIR INTAKE AND GAS EXHAUST SYSTEM MODEL NO. 3/14/1B, 3/14/2B, 3/14/3B, 3/14/4 AND 3/14/5

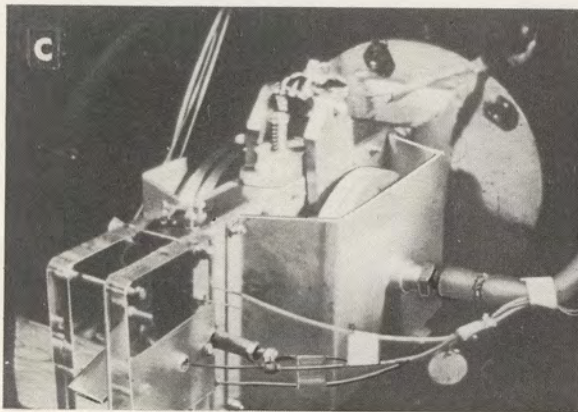
~~SECRET~~



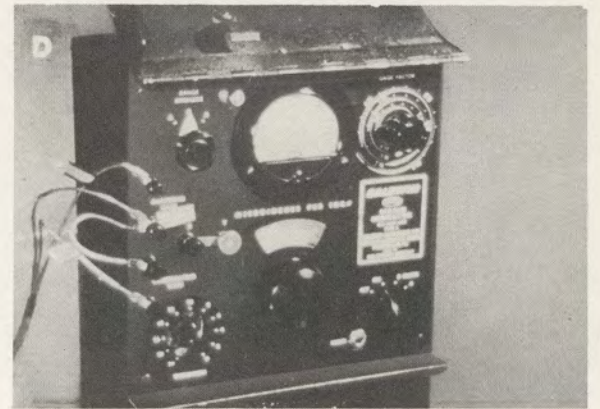
A
Installation of Model and Test Rig



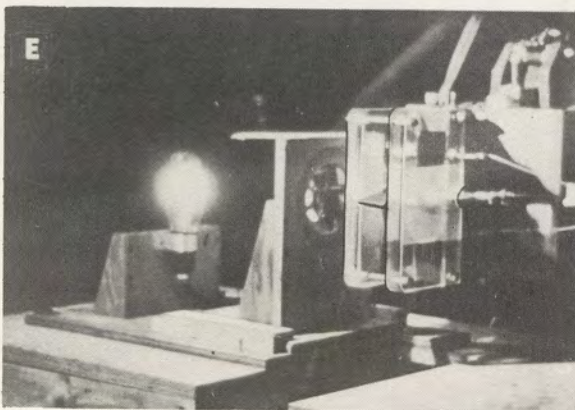
B
Control Panel and Manometer Bank



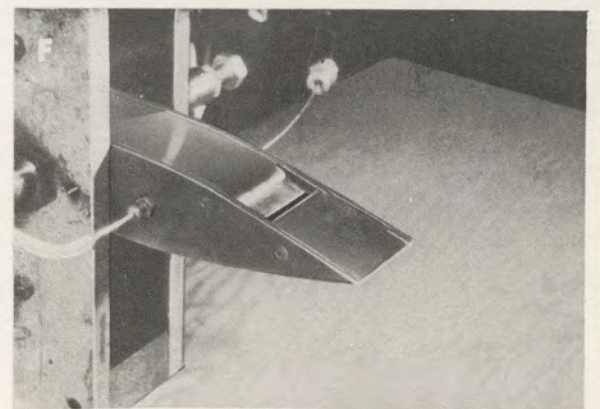
C
Close-up of Model and Rig



D
Strain Recording Equipment



E
Shadowgraph Installation



F
Close-up of Type 2 Nozzle

1372-1794-1

FIG. 51 Thrust Recovery Tests (Series No. 1) at Nobel

~~SECRET~~

5.1.4.2
(Cont'd)

reinforce the moment augmentation measured on the 1/23 scale supersonic model.

Broad conclusions were as follows:

- (i) In the region of 60% of the thrust of a plain nozzle facing backwards in the same model and having the same pressure ratio and mass flow was recovered in the stream direction by the right-angled jet.
- (ii) The moment produced by the jet exhausting about at right angles to the surface into the supersonic stream was 1.8 times the moment so obtained without the supersonic stream blowing.

5.1.4.3 End Loss Test - Considering internal losses, the following regions may be isolated:

- (i) The air intake (section 5.1.1.3)
- (ii) The centrifugal compressor
- (iii) The diffuser duct
- (iv) The flame holder and combustion section
- (v) The nozzle end loss

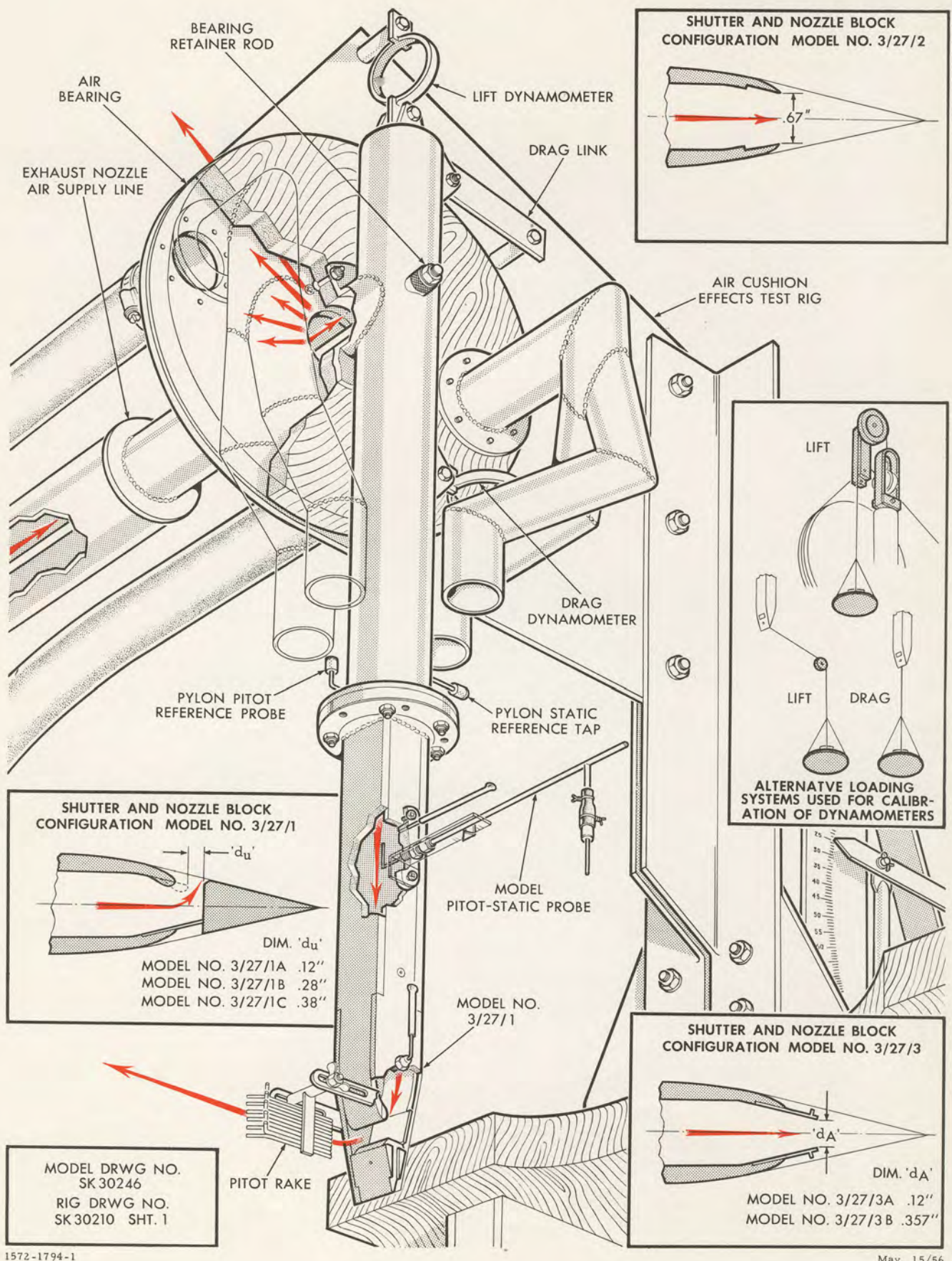
Data exists from which the centrifugal compressor efficiency and flame holder pressure losses may be estimated with tolerable accuracy. The diffuser loss is not expected to be high since the diffusion angle is optimum and the flow straight and tests appear to confirm this (section 5.1.4.1). The nozzle end loss is thus prominent as a point of doubt and data is lacking as to the loss

5.1.4.3
(Cont'd)

associated with this type of sharply accelerating variable corner. Since the 45° segment was no longer representative, a short series of tests were run late in the contract period on a moderately representative right angle bend. This rig (Fig. 52) consisted of the thrust recovery model suitably modified and fitted to the ground effect balance. Thrusts were measured before and after bending at the same pressure and mass flow and the loss converted to a pressure loss factor at the minimum area before the final bend.

Further tests are required on a fully representative larger scale specimen. A 1/3rd scale nozzle end loss test of the actual aircraft nozzle is proposed and is now being manufactured for testing at the contractor's facility.

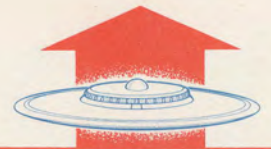
- 5.1.5 Performance tests: Tests in favour of evaluating performance are principally concerned with wind tunnel model data on drag and are described in section 5.1.1.
- 5.1.6 Radial flow feasibility: No tests have been carried out relative to the propulsion system per se.
- 5.2 Design Study and Theoretical Analysis
- 5.2.1 Ground Effect: An attempt was made to calculate the ground cushion effect theoretically by assuming a flow structure similar to that observed. A curve of the right general form was obtained.



1572-1794-1

May, 15/56

FIG. 52 AIR INTAKE AND GAS EXHAUST SYSTEM-MODEL NO. 3/27/1, 3/27/2 AND 3/27/3



5.2.1
(Cont'd)

However, the high point at half span from the ground could not be predicted. No detailed effects, such as that of jet angle, have been attempted theoretically.

5.2.2 Stability and Control Analysis: For stability, aerodynamic and control derivatives and basic airplane data were taken from preliminary tests and studies since there has not been sufficient time to re-work the analyses on the basis of the wind tunnel tests of section 5.1.1, and the latest airplane quantities. However, the preliminary values are sufficiently accurate for a clear picture of the basic longitudinal stability problem to be obtained. During the course of the year the preferred system for operating the shutters to control the jets to obtain artificial stability has developed through the hydraulic system with mechanical linkage to the pneumatic system with the actuation built into the shutter itself and also providing cooling. (Fig. 7, Page 12). Both systems have been examined theoretically and it appears that the pneumatic system will give a faster response also.

The following analyses have been made:

- (1) Longitudinal stability of the aircraft using a simple control equation.
- (2) Longitudinal stability of the aircraft using a second order control equation.

5.2.2
(Cont'd)

- (c) Lateral stability of the aircraft using a second order control equation.
- (4) Estimate of the time constant of the pneumatic control system.
- (5) Longitudinal transient response characteristics of the aircraft and control system using a simple time lag transfer function.
- (6) Hovering stability and control.

General conclusions which can be drawn from these studies are as follows:

- (i) It appears that the stability and control system proposed can be satisfactorily developed to provide flying qualities similar to those of conventional airplanes.
- (ii) There is sufficient control power in the jet controls to achieve stability over the whole flight range up to extreme altitudes from low speed at sea level to very high speed at extreme altitude (90-100,000 feet).
- (iii) In contra-distinction of the aircraft of Fig. 1, Page 4, there are no gyroscopic reactions on the aircraft from the main rotors, since these are balanced by the contra-rotation; and only used to provide a measure of the rate of pitch or roll.

5.2.3 Air Intake and Gas Exhaust Systems: The analyses made under this heading have been devoted to the study of test results and have already been described in section 5.1.4.

5.2.3.
(Cont'd)

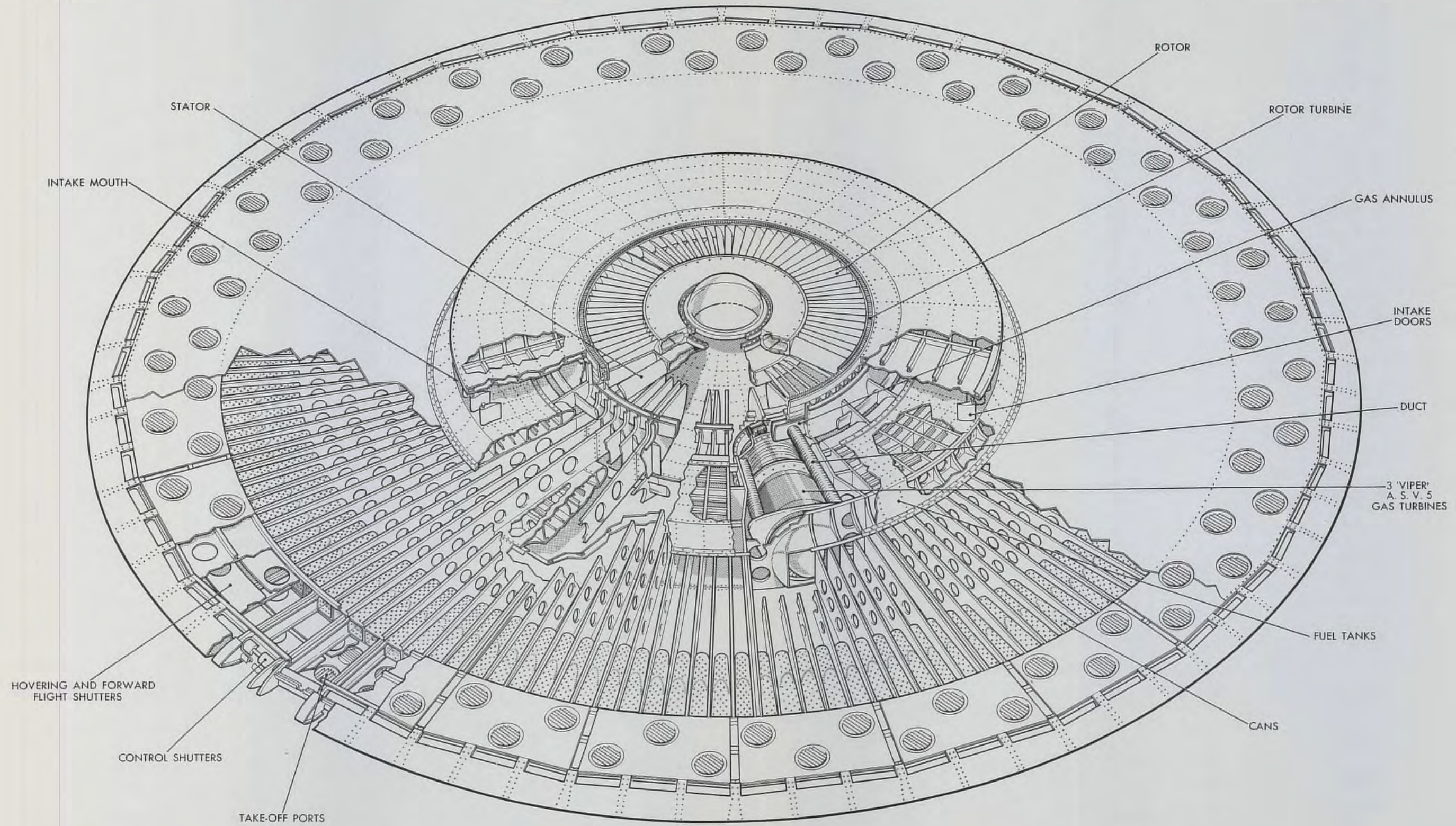
NOTE: The Work Statement for the contract calls for study into "The effect of flow distortions on blade vibration and engine performance". This is no longer applicable to the subject aircraft in its present form. Therefore no analysis has been made.

5.2.4 Aircraft Performance: Estimates for performance have been made for the subject aircraft at each development stage, consisting principally of thrust and drag analyses and estimates and calculations of the resulting performance characteristics.

The performance of the six Viper research aircraft "Project 704" is superior to the earlier designs by a wide margin.

Drag analyses have now been confirmed by supersonic tests and the resulting performance has already been summarized earlier in this report under section 4.3, Figs. 9 through 11.

5.2.5 Radial Flow Feasibility: A considerable amount of design study has been carried out in developing the desired type of propulsion system to the form shown in Fig. 4, Page 7. To illustrate this Figs. 53, 54 and 55 are shown on the following pages, together with a repeated Fig. 4 for comparison. These depict the configurations explored. Briefly, the initial proposal of Fig. 53 fitted three Viper engines with their jets facing outboard and exhausting over small arcs of the periphery. A large percentage of the mass



AVRO

IN

HOVERIN
FLIG

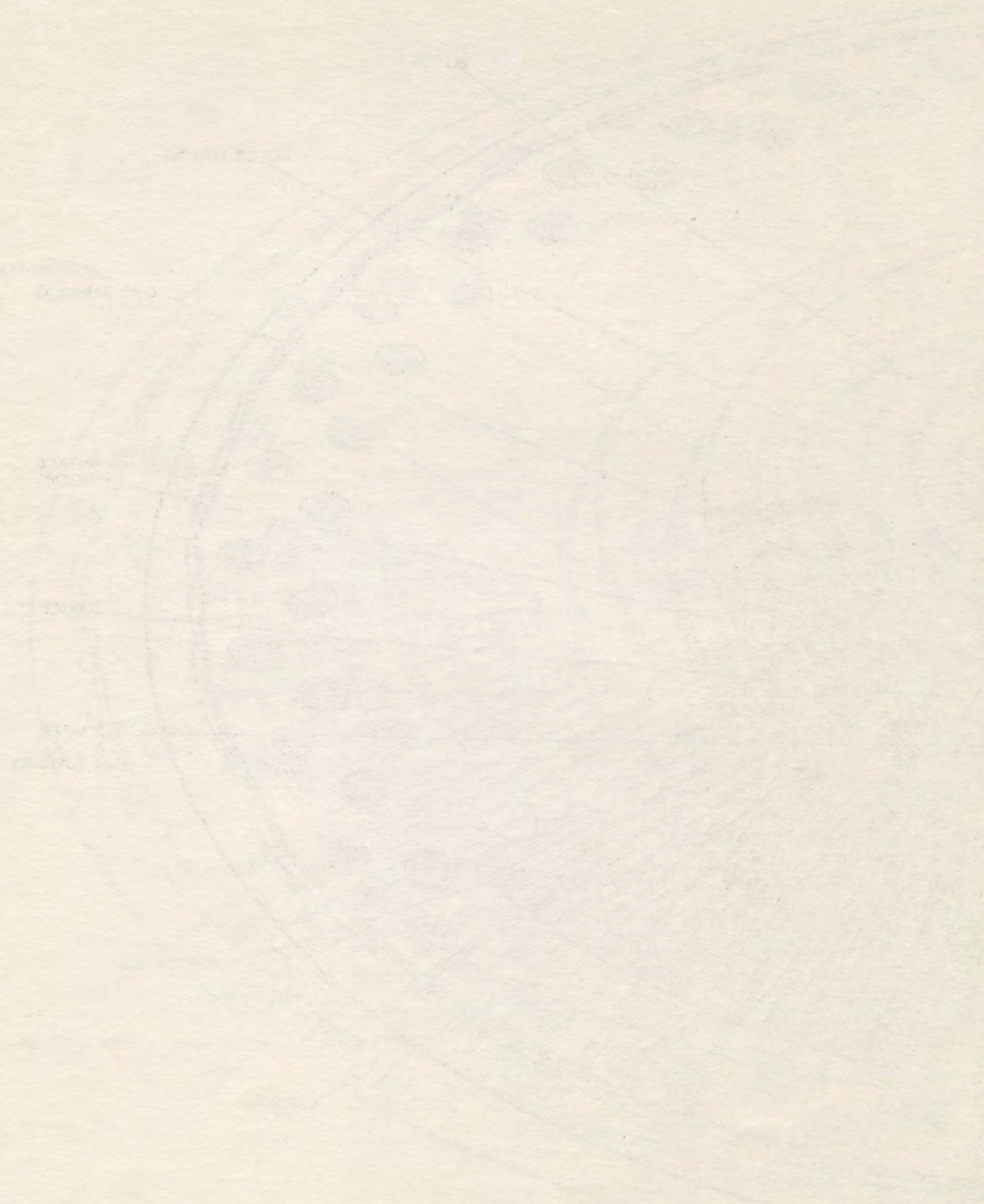
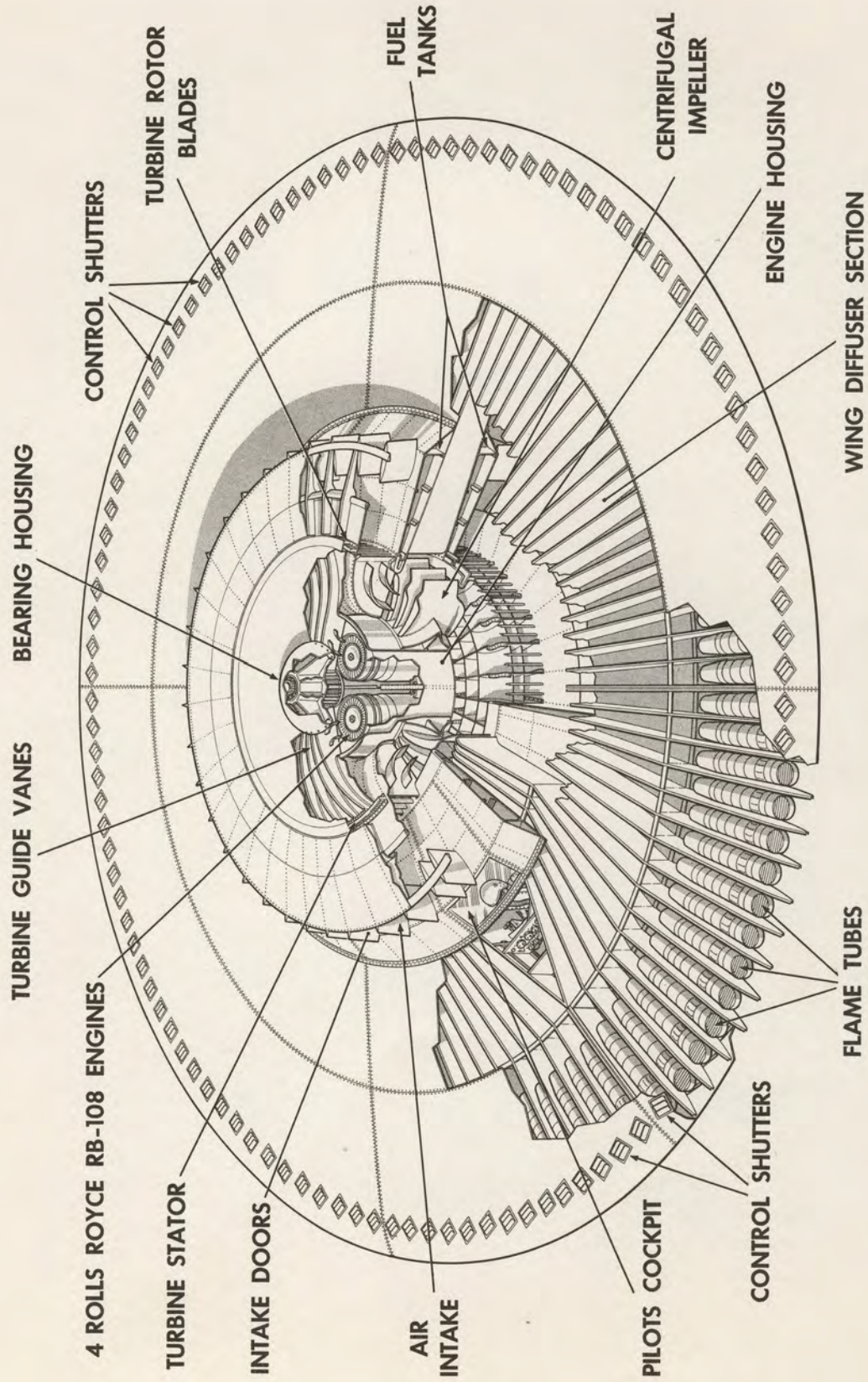


FIG. 53

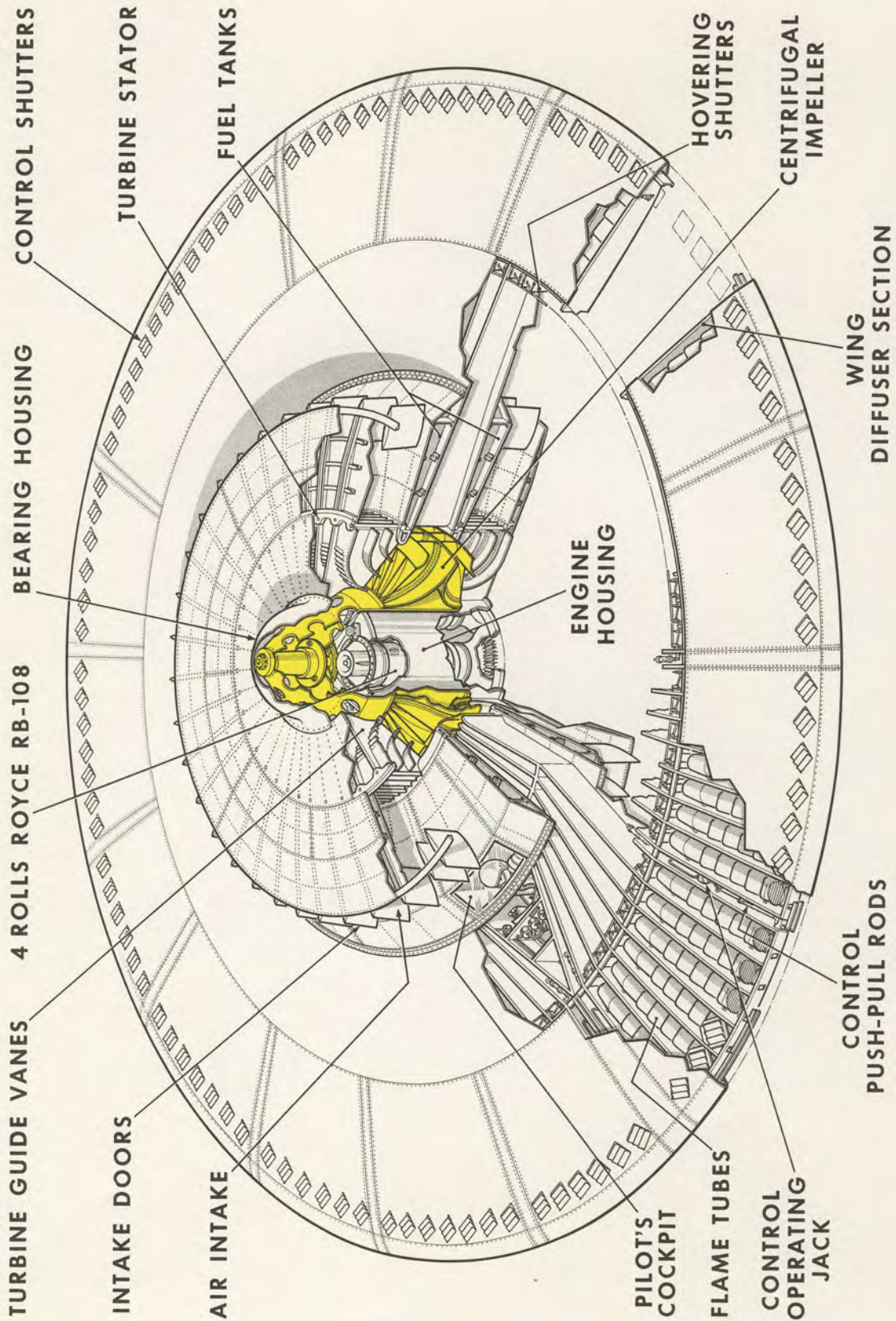
CUTAWAY OF 3 VIPER DUCTED FAN A/C

548-1794-



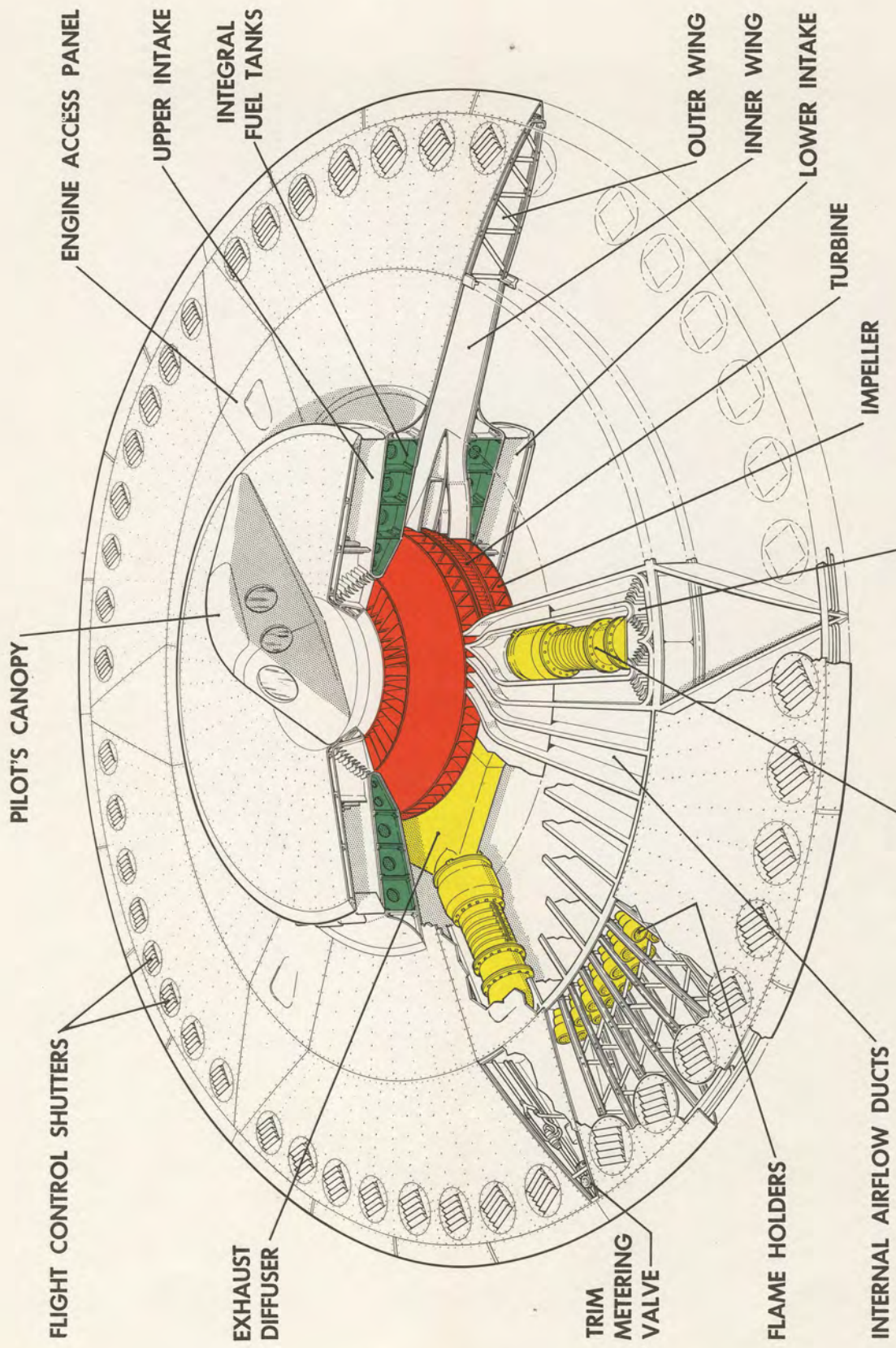
RAMJET AIRCRAFT - DUCTED FAN ASSISTED
FIG. 54

763-1794-1



RAMJET AIRCRAFT-DUCTED FAN ASSISTED
FIG. 55

1018-1794-1



ASM-VIPER 8 ENGINE ENGINE AIR INTAKE
6-VIPER DUCTED FAN RAMJET DESIGN
FIG. 4

5.2.5
(Cont'd)

flow was bled from these engines, separately combusted and exhausted through a large diameter turbine attached to the tip of a single stage axial impeller, as can be seen in the drawing of Fig. 53. A large mass flow of air was driven through the wing by this impeller and, with provision for secondary combustion, exhausted over the wide sectors in between the Viper engines. For forward flight the impeller was by-passed altogether and the aircraft became a pure ramjet. It was thus strictly a high mass flow ducted fan arrangement for take-off and ramjet for supersonic flight. The difficulties with the impeller turbine arrangement, expected poor transition characteristics, and low thrust at subsonic speeds were principal objections to this scheme.

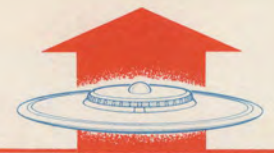
In the aircraft of Fig. 54 a single large centrifugal impeller was used and driven by four Rolls Royce R. B. 108 engines; mounted vertically in a close cluster in the centre of the aircraft with their exhausts facing upwards and used as gas generators to power a large diameter radial out-flow turbine, which formed an integral part of the centrifugal impeller. Considerable analysis of this propulsion unit was made (Area Report No. 5 - AVRO/SPG/TR2). The arrangement appeared very promising, the principal objection being centred in the mechanics of the main rotor and the position of the turbine exhaust.

The aircraft of Fig. 55 was then studied. In this the engines were

5.2.5
(Cont'd)

reversed to exhaust downwards through a relatively small diameter axial flow turbine. This turbine was mounted on a central shaft and drove a similar large centrifugal impeller through a big reduction gear at the top of the aircraft. This propulsion system was also analysed, (Area Report No. 5 AVRO/SPG/TR26). The reduction gear was required to transmit in the region of 16,000 H. P. for take-off and the impeller structure was somewhat unwieldy. These development problems appeared quite manageable. However, the engine supply position for the Rolls Royce R. B. 108, or any alternative sufficiently short to fit upright in the small research airplane, was rather doubtful. A design was therefore sought which would enable a bona-fide off-the-shelf engine, such as the Armstrong Siddeley Viper to be used and this resulted in the aircraft of Fig. 4, Page 82.

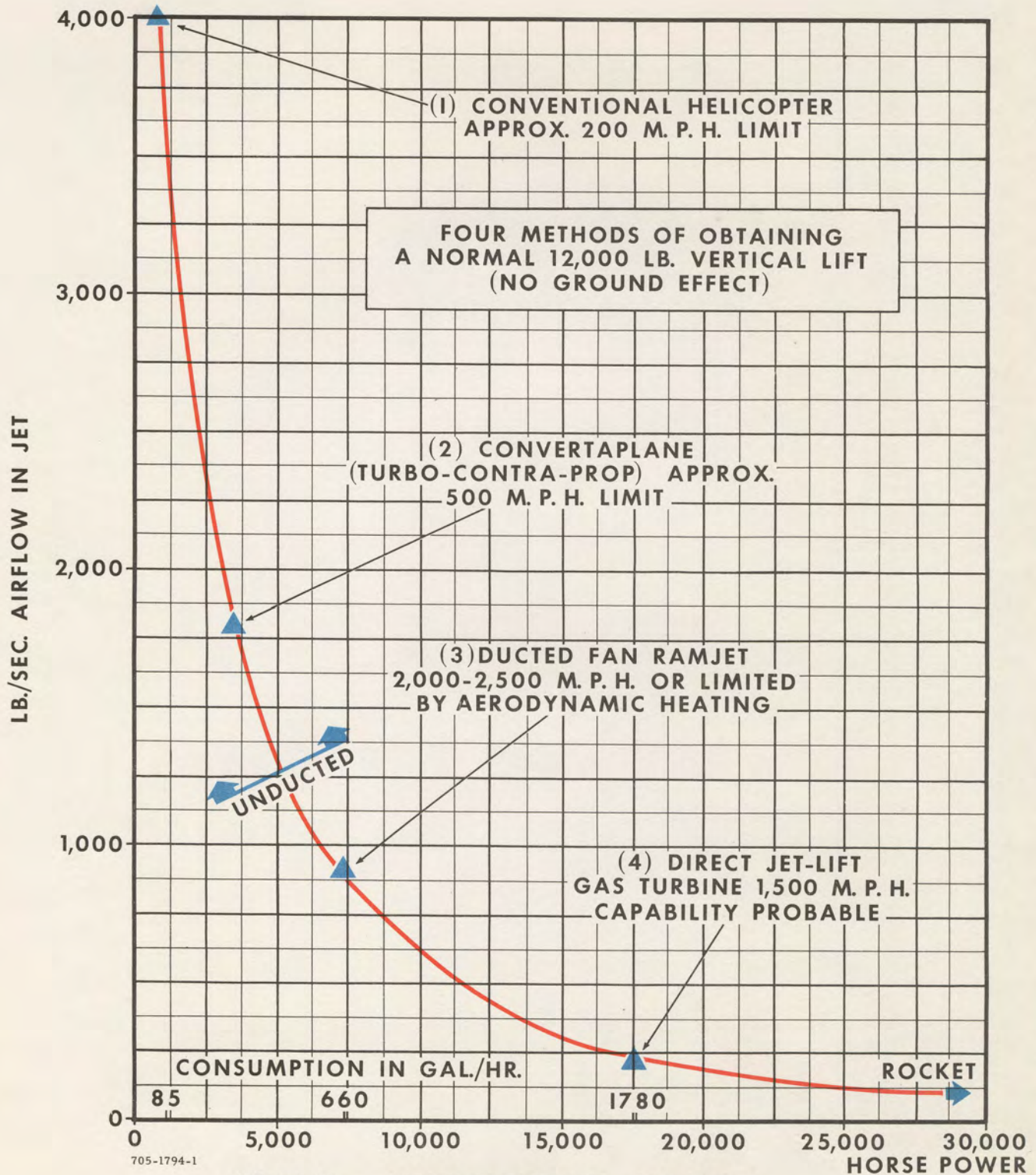
In Project 704, as described in section 4, the main centrifugal impeller has been split into two halves mounted directly off a central shaft. The Viper engines, which are too long to fit vertically in the aircraft, are laid flat in the wing and drive the impellers through a radial in-flow turbine exhausting downwards. Project 704 thus avoids a development problem of a very large reduction gear and provides a superior impeller structure and bearing arrangement. This propulsion system is different from the earlier design in that the engine intakes are pressurized by



5.2.5
(Cont'd)

the main impellers so that the propulsion unit thermodynamically resembles a two spool by-pass gas turbine. To provide high static thrust efficiency, and the very large air swallowing capacity required, the by-pass ratio is very high (5 to 1). An analysis of the thrust and specific fuel consumption to this power plant over a wide range of operating conditions is presented in Area Report No. 5 (AVRO/SPG/TR14).

The static thrust efficiency is illustrated by the chart Fig. 56: this chart shows four methods of obtaining 12,000 lb. vertical lift (without ground effects) lying on a curve illustrating the variation of H. P. required with "jet" mass flow. Most efficiently, a very large mass flow is used, as in the helicopter in which the jet is the whole flow passing through the rotor. The next alternative is the convertiplane shown which has a much smaller rotor and "jet" but also has a greater speed range. In direct jet lift (4) a very concentrated jet is used but this is seen to be extravagant in H. P. required and fuel consumed. Project 704 is represented as requiring less than half the H. P. of direct high energy jet lift. It is clear from this curve, however, that some cross-over point occurs where the "jet" is ducted within rather than around the aircraft and a large internal mass flow can still be used for static lift. Equally when the large mass flow can be ducted through the aircraft it can also be reheated to produce a very large installed thrust.



V.T.O. EFFICIENCY CHART
FIG. 56

FINANCIAL STATEMENT

1 JUNE, 1956

6. TABULATED LABOUR & COST SUMMARY

The cost summary covers the period July 1st, 1954 to June 1st, 1956 and details separately the costs incurred during the anticipatory period - July 1st, 1954 to April 1st, 1955. The manhours and costs of each of the five areas of Investigation incurred during the contract period - April 2nd, 1955 to June 1st, 1956 - are as follows:

<u>AREA OF INVESTIGATION</u>	<u>MANHOURS</u>	<u>COST</u>	<u>TOTAL</u>
Air Cushion Effect & Test			
- Engineering	2,395.00	\$ 13,021.76	
- Manufacturing	<u>1,877.50</u>	<u>11,507.23</u>	
	4,272.50		\$ 24,528.99
Stability & Control Analysis & Test			
- Engineering	24,080.00	\$ 137,430.11	
- Manufacturing	<u>33,775.00</u>	<u>187,502.27</u>	
	57,855.00		324,932.38
Air Intake & Gas Exhaust System Test			
- Engineering	4,246.25	\$ 19,406.63	
- Manufacturing	<u>6,870.75</u>	<u>42,710.44</u>	
	11,117.00		62,117.07
Airplane Performance Analysis & Test			
- Engineering	2,776.25	\$ 14,239.85	
- Manufacturing	<u>603.25</u>	<u>3,159.22</u>	
	3,379.50		17,399.07
Radial Flow Engine Feasibility			
- Engineering	4,097.25	\$ 24,933.88	
- Manufacturing	<u> </u>	<u>(13.62)</u>	
	4,097.25		24,920.26
	<u>80,721.25</u>		<u>\$ 453,897.77</u>

These costs (\$453,897.77) together with the costs for the anticipatory period (\$287,921.22) aggregate to the total of \$741,818.99 - leaving a balance of funds at



the end of May 1956 amounting to \$19,824.00 and this is anticipated to be adequate to cover the cost of producing the remaining reports required under the terms of the contract.

TABULATED LABOUR AND COST SUMMARY

July 1, 1954 - June 1, 1956
(including anticipatory costs)

<u>ENGINEERING</u>	Hours Expended	Production Labour	Experimental Labour	Salaries	Material	Direct Charges	Applied O/Head	Admin O/Head	Total Cost
Anticipatory Period	29,867.75			73,311.38	29.30	-	80,199.88	8,109.36	161,649.92
Air Cushion Effect Test and Analysis	2,395.00			5,991.08	-	-	6,078.43	952.25	13,021.76
Stability and Control Analysis and Tests	24,080.00			61,194.51	136.82	1,332.00	65,768.93	8,997.85	137,430.11
Air Intake and Gas Exhaust System Tests	4,246.25			9,939.32	57.88	-	7,417.99	1,991.44	19,406.63
Aircraft Performance Analysis and Tests	2,776.25			6,529.97	-	-	6,676.70	1,033.18	14,239.85
Radial Flow Engine Feasibility	4,097.25			11,468.15	-	-	11,886.68	1,579.05	24,933.88
ENGINEERING TOTAL	67,462.50	-	-	\$168,434.41	\$ 224.00	\$ 1,332.00	\$178,028.61	\$22,663.13	\$370,682.15
<u>MANUFACTURING</u>									
Anticipatory Period	20,318.75	7,703.66	28,183.16	6,341.10	21,910.83	6,007.13	49,807.59	6,317.83	126,271.30
Air Cushion Effect Test and Analysis	1,877.50	167.94	3,574.38	50.37	353.82	1,764.52	4,744.49	851.71	11,507.23
Stability and Control Analysis and Tests	33,775.00	8,066.05	56,601.99	3,715.04	14,374.28	4,048.01	88,375.86	12,321.04	187,502.27
Air Intake and Gas Exhaust System Tests	6,870.75	1,370.52	11,630.58	800.49	6,174.94	3,304.21	16,217.49	3,212.21	42,710.44
Aircraft Performance Analysis and Tests	603.25	41.27	930.16	305.11	44.88	-	1,625.35	212.45	3,159.22
Radial Flow Engine Feasibility	-	-	-	-	(8.25)	-	(23.83)	18.46	(13.62)
MANUFACTURING TOTAL	63,445.25	\$17,349.44	\$100,920.27	\$ 11,212.11	\$42,850.50	\$15,123.87	\$160,746.95	\$22,933.70	\$371,136.84
GRAND TOTAL	130,907.75	\$17,349.44	\$100,920.27	\$179,646.52	\$43,074.50	\$16,455.87	\$338,775.56	\$45,596.83	\$741,818.99

All Amounts shown are in Canadian Currency

Antic

Air C

Stabi

Air I

Airc

Radi

EN

Antic

Air C

Stabi

Air I

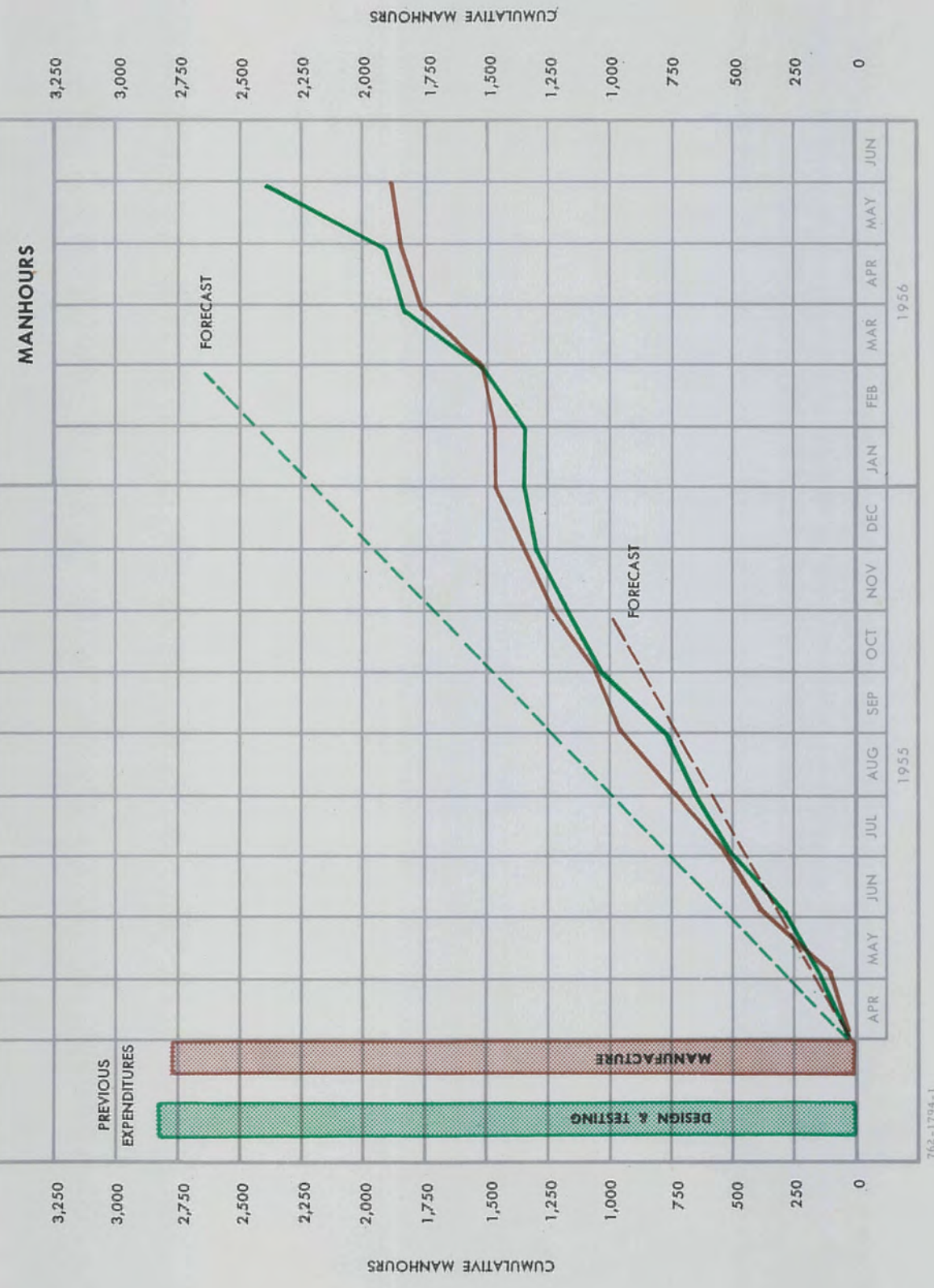
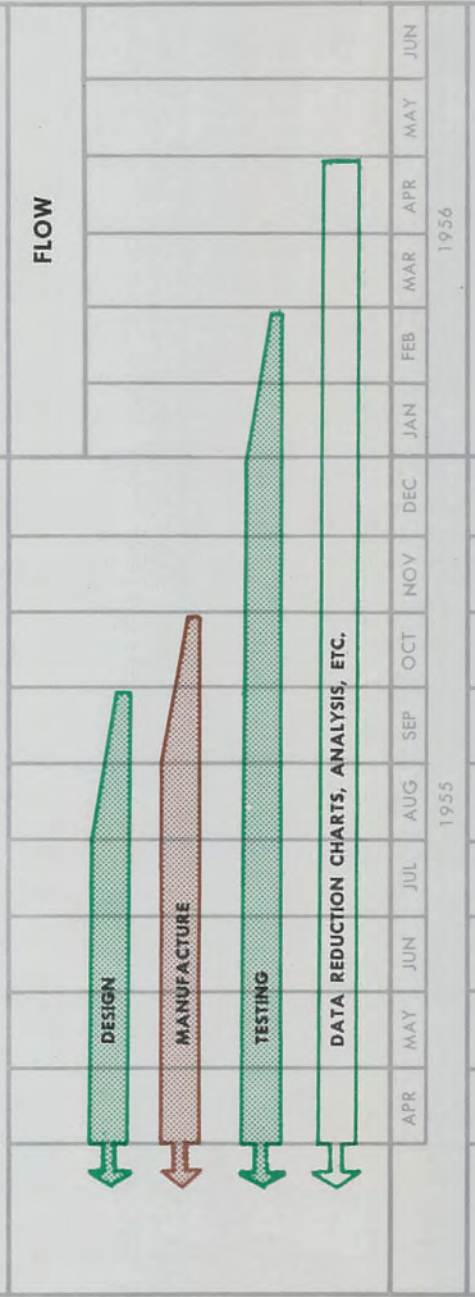
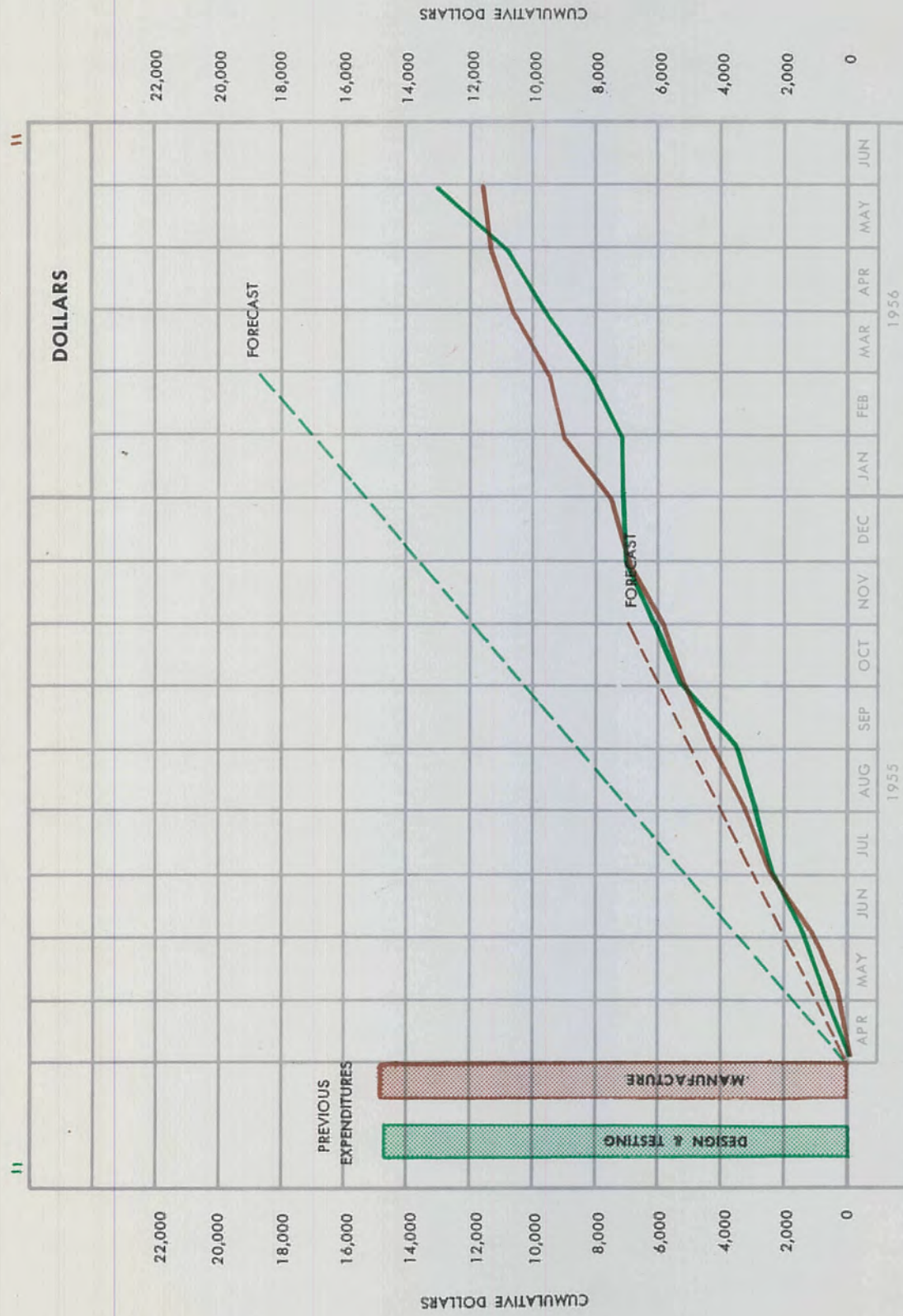
Airc

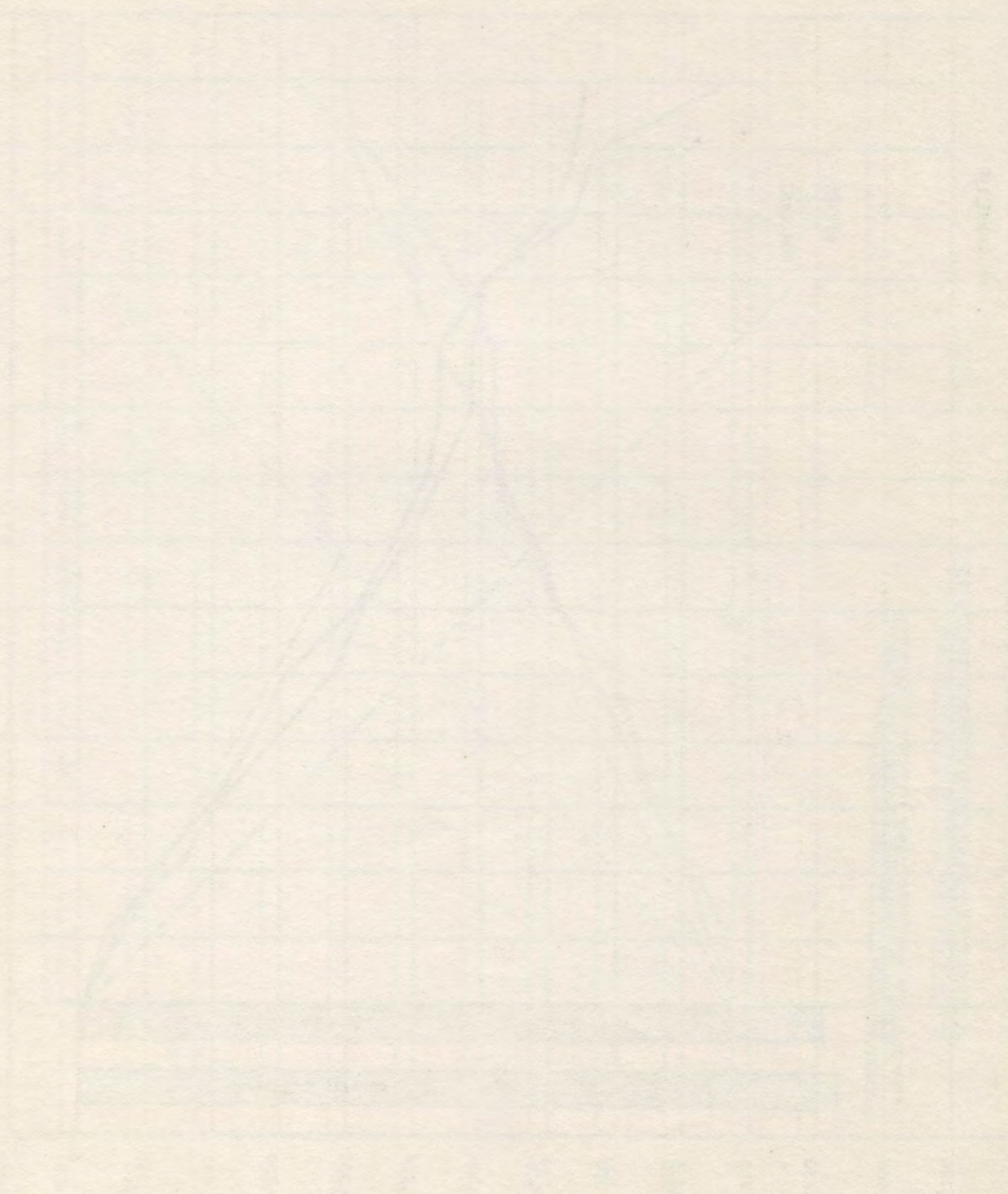
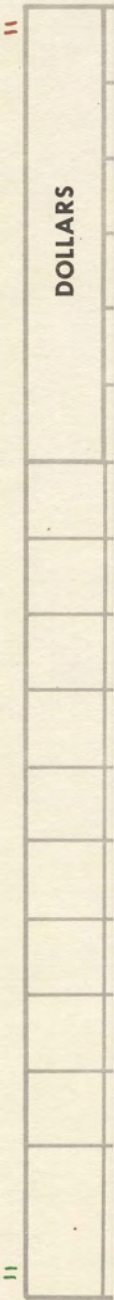
Radi

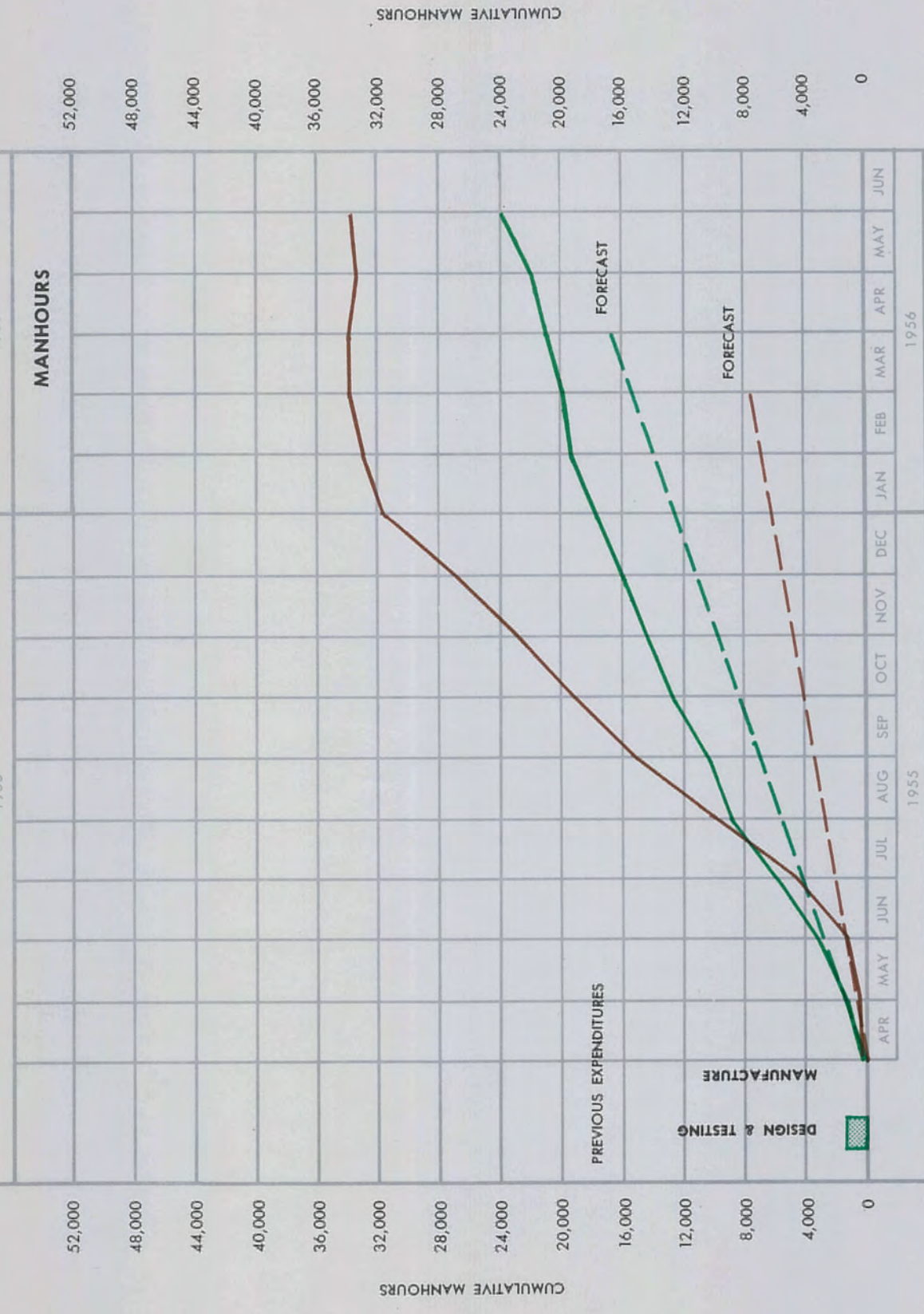
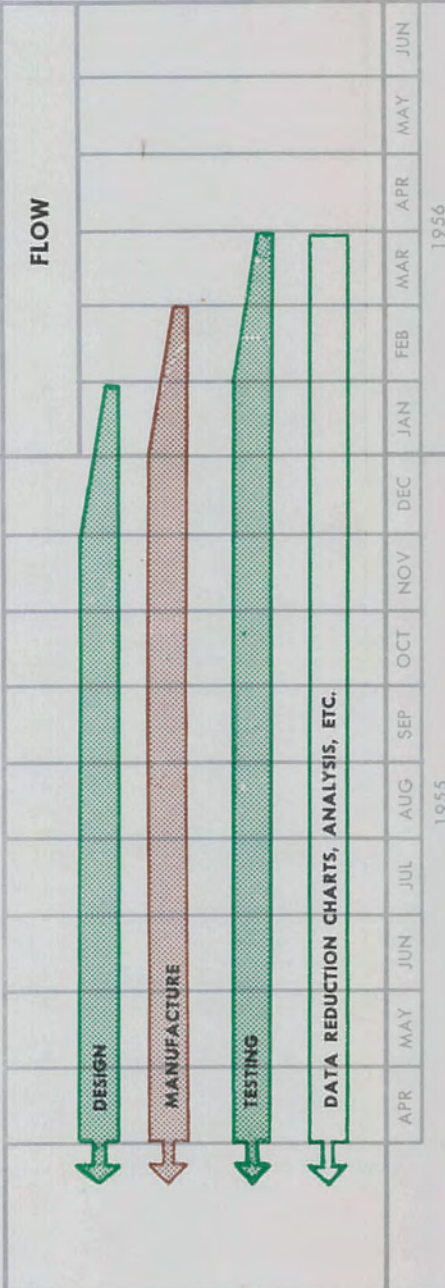
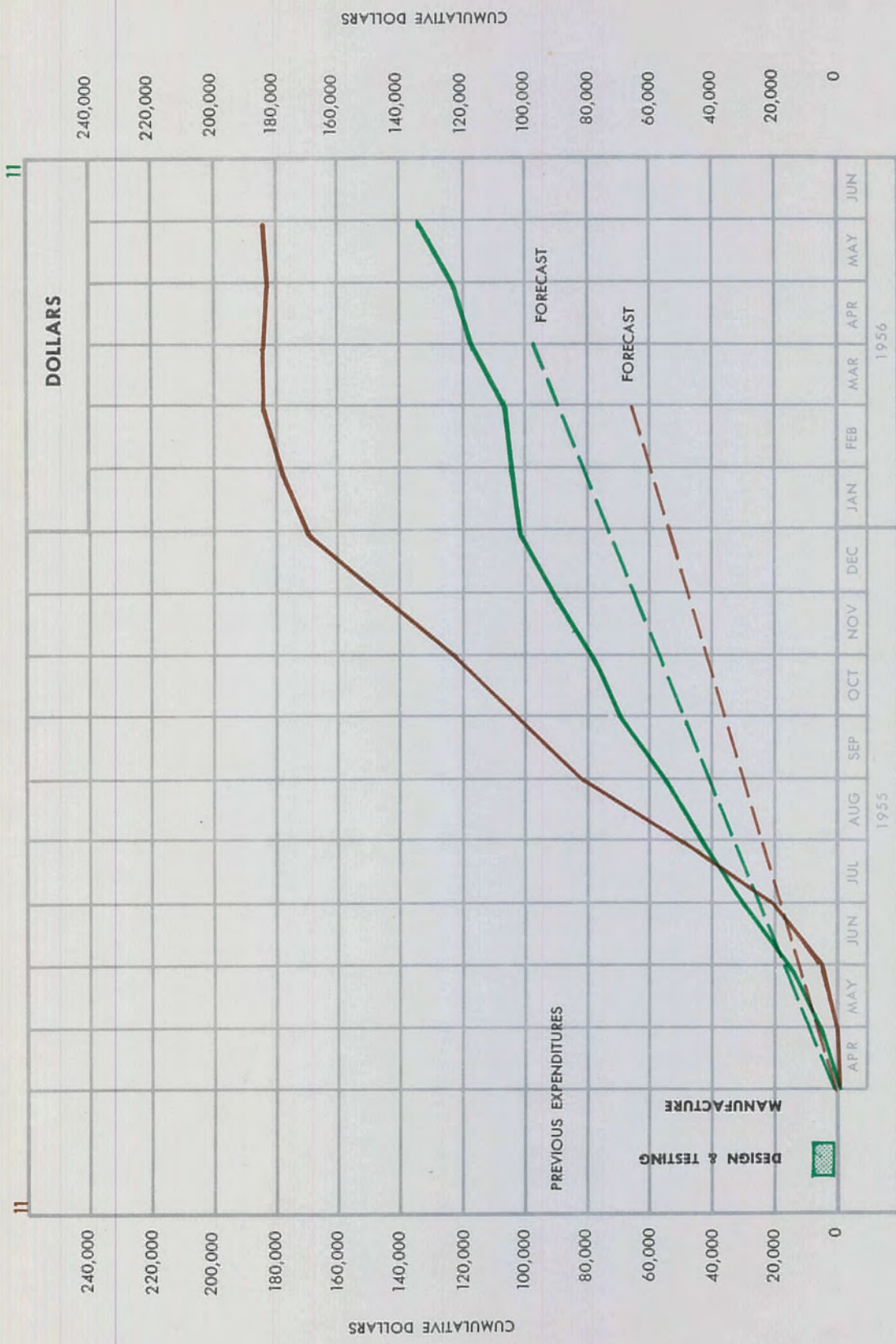
Ma

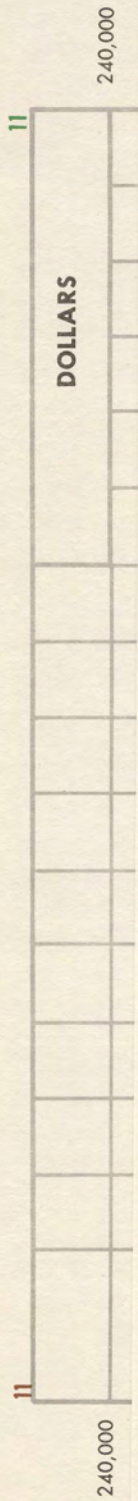
GR

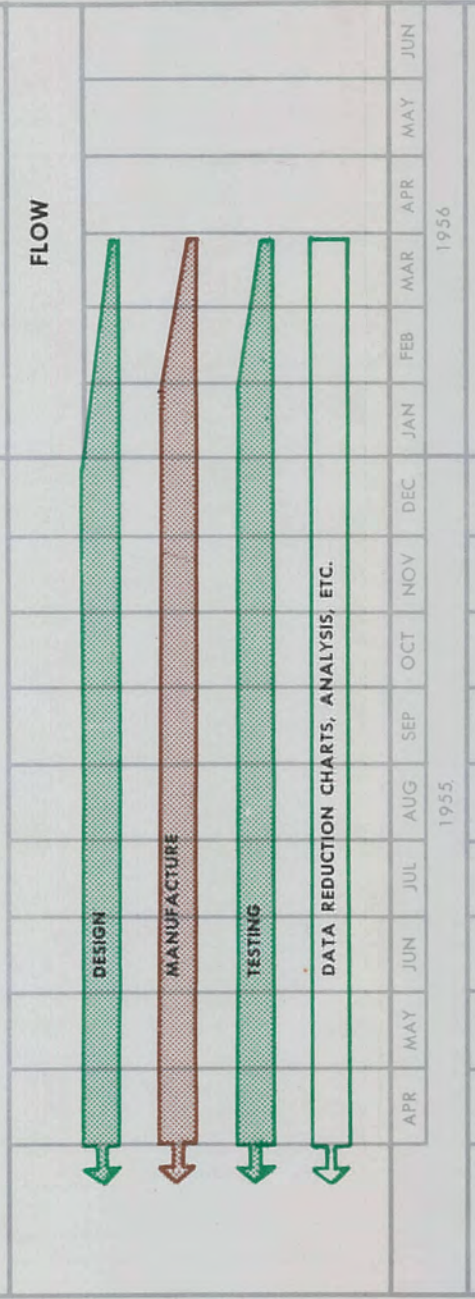
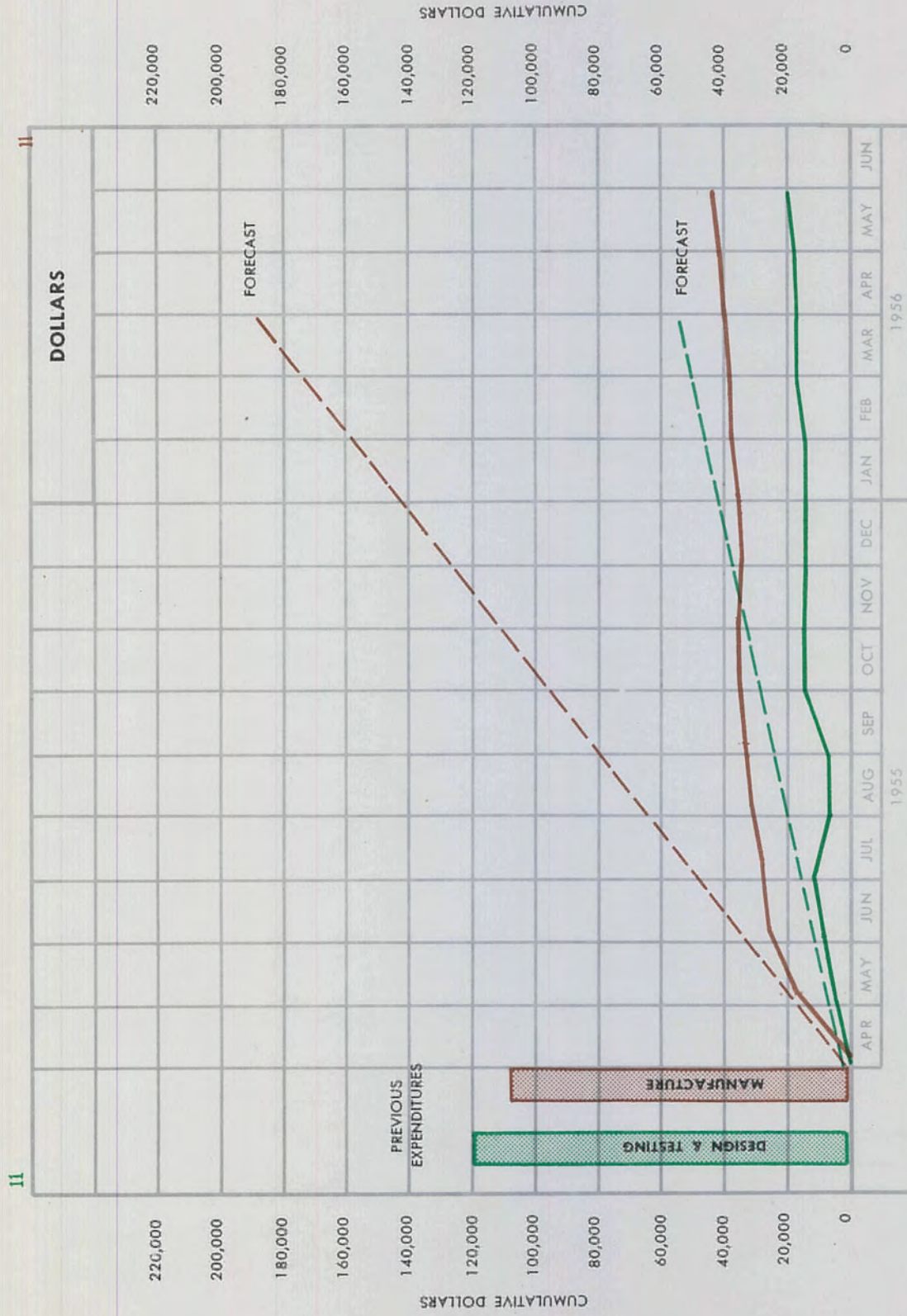
Al





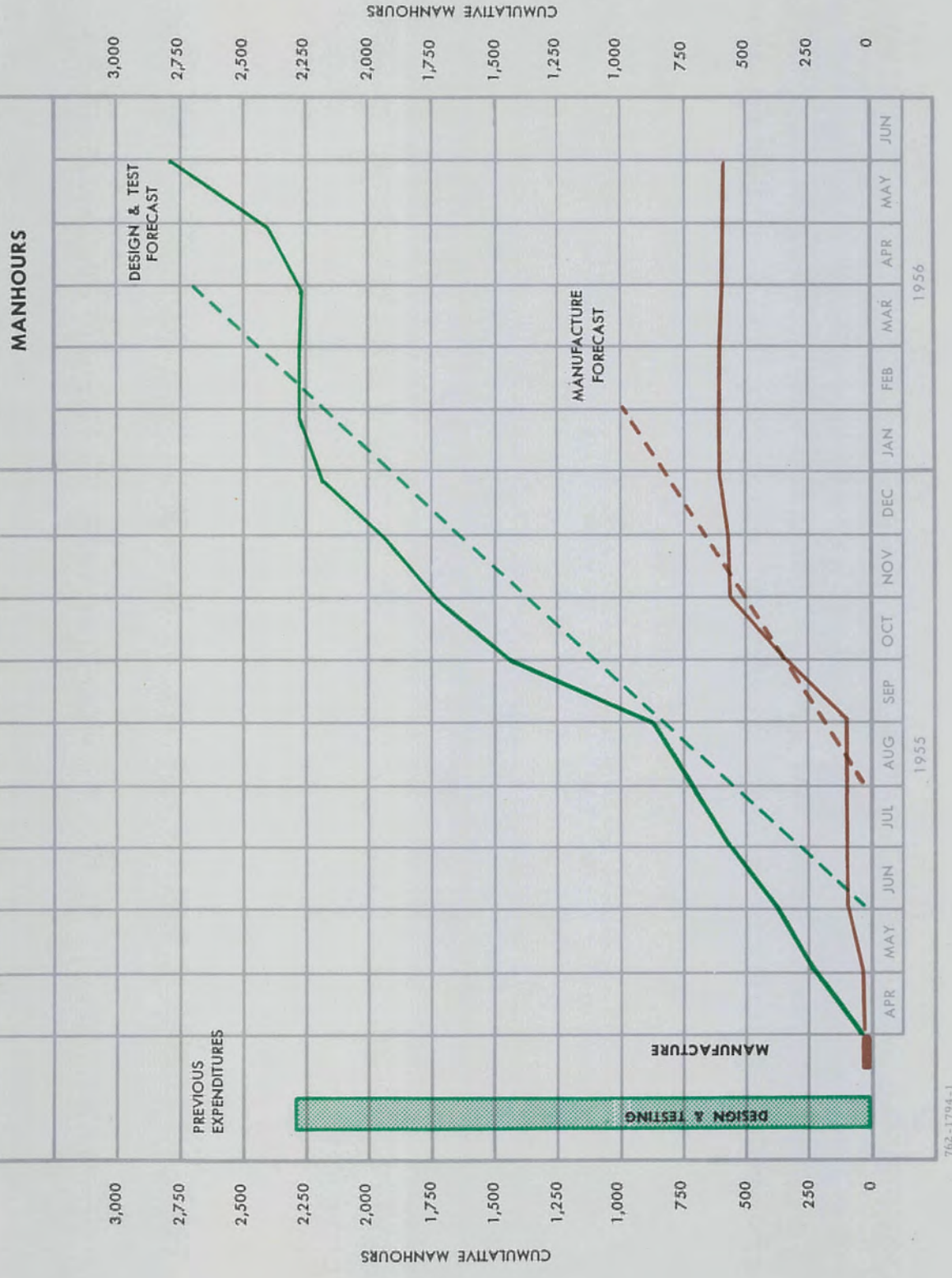
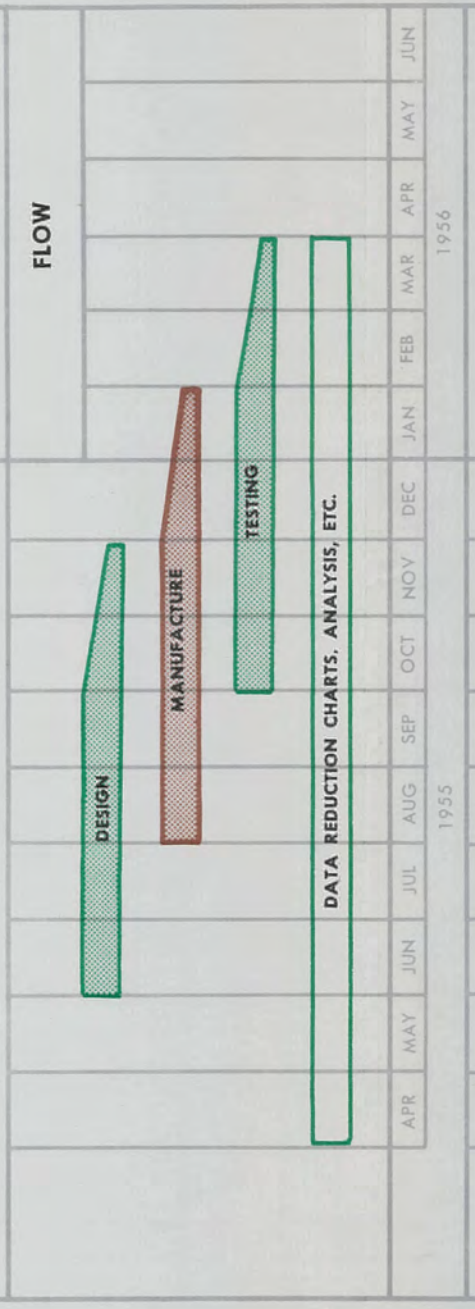
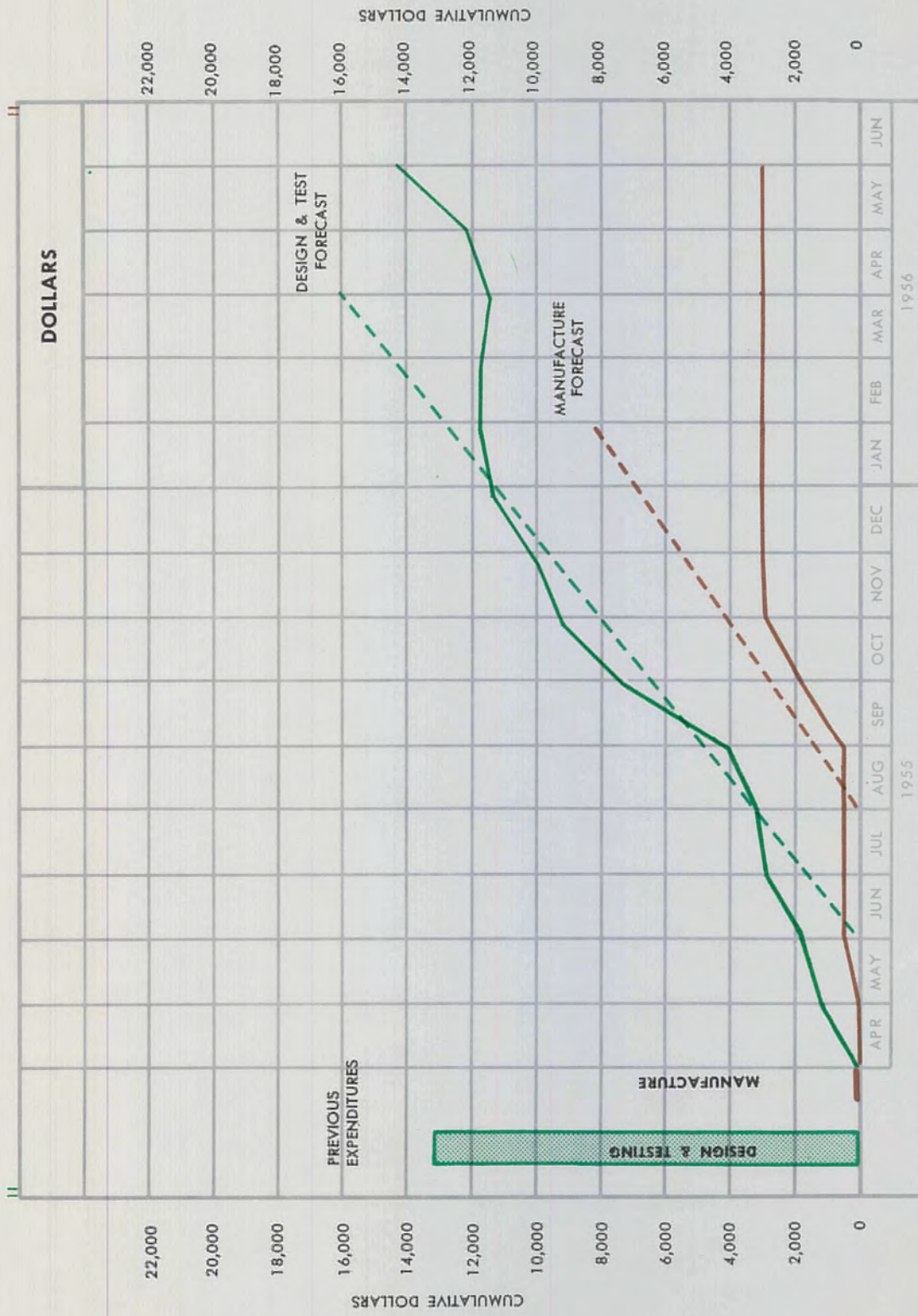


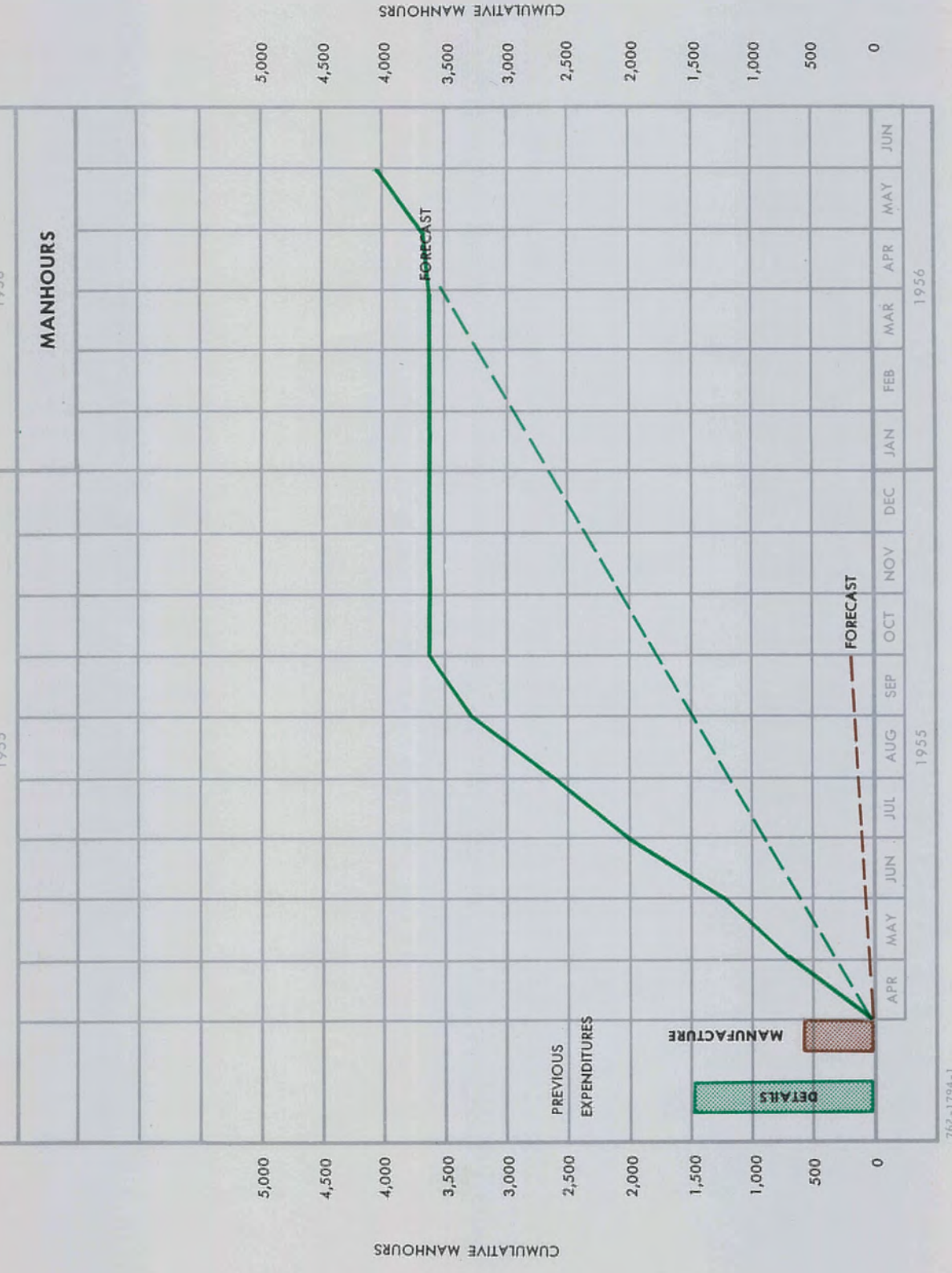
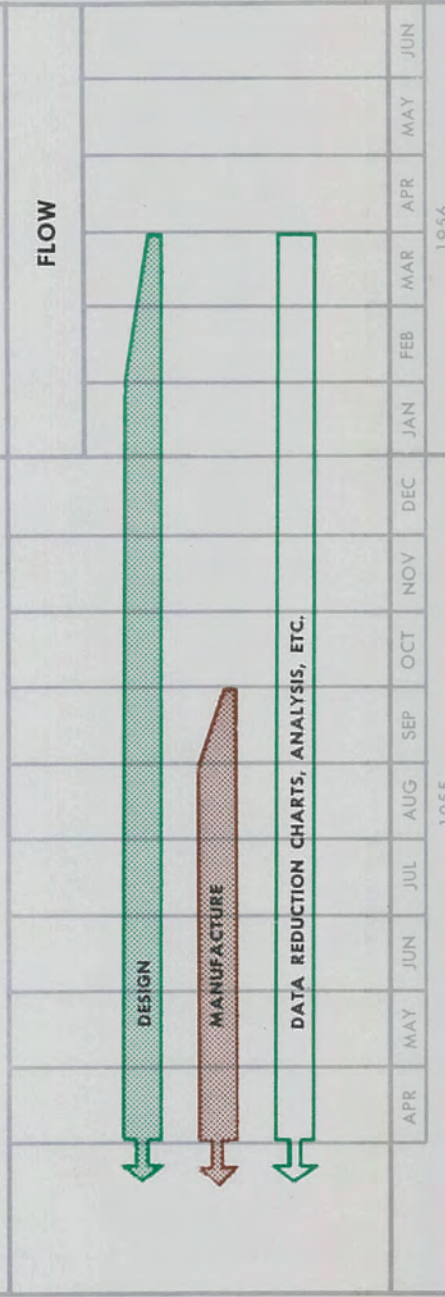
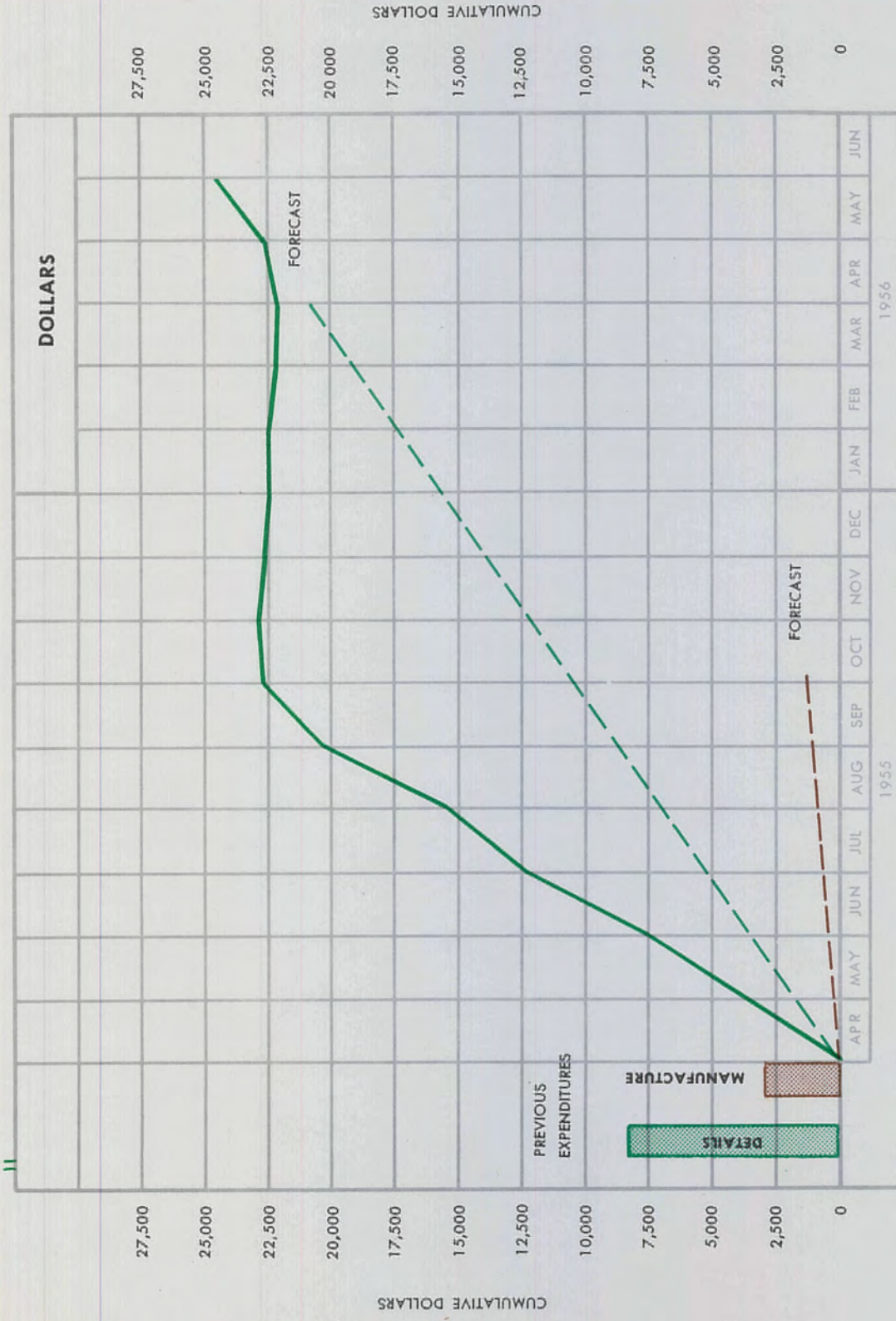


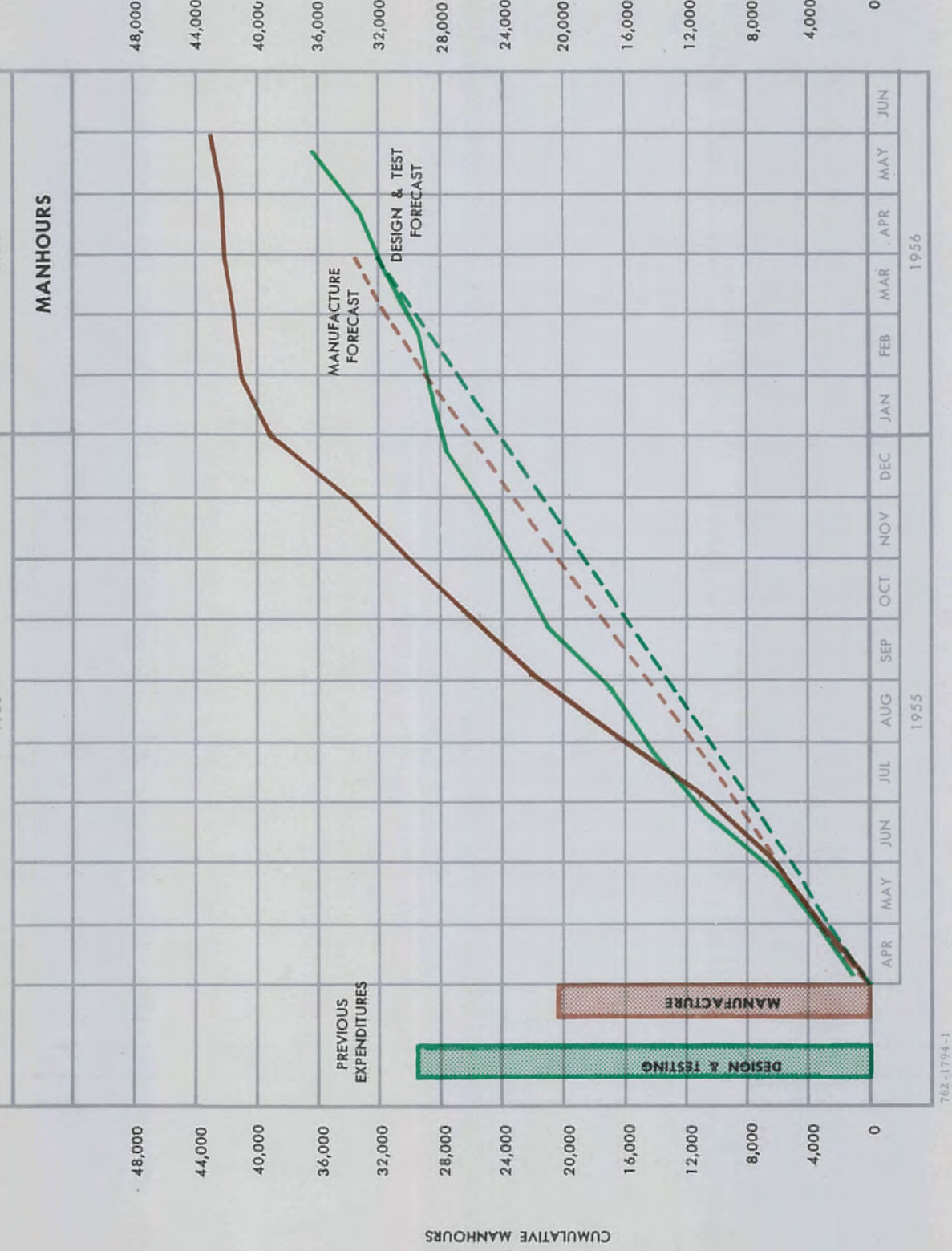
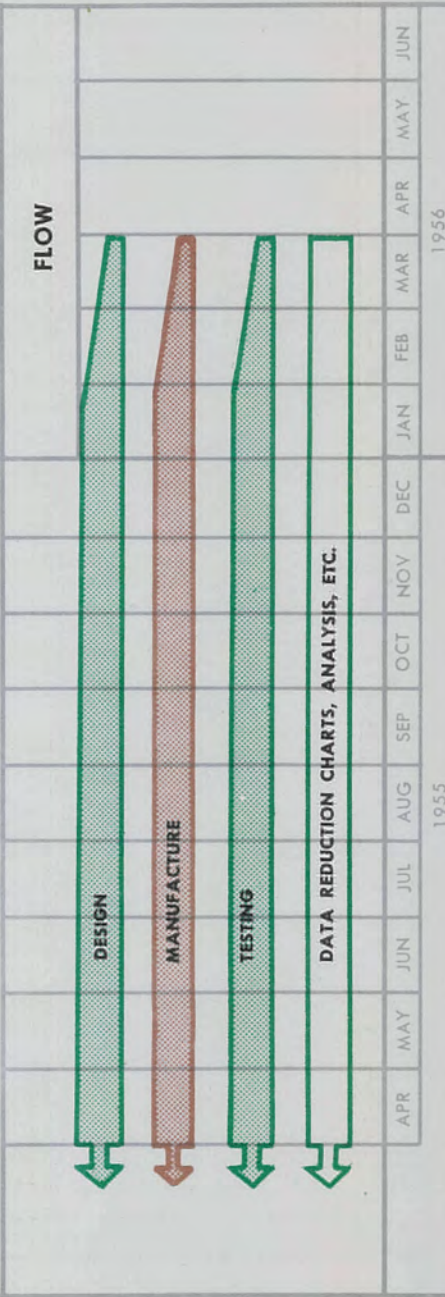
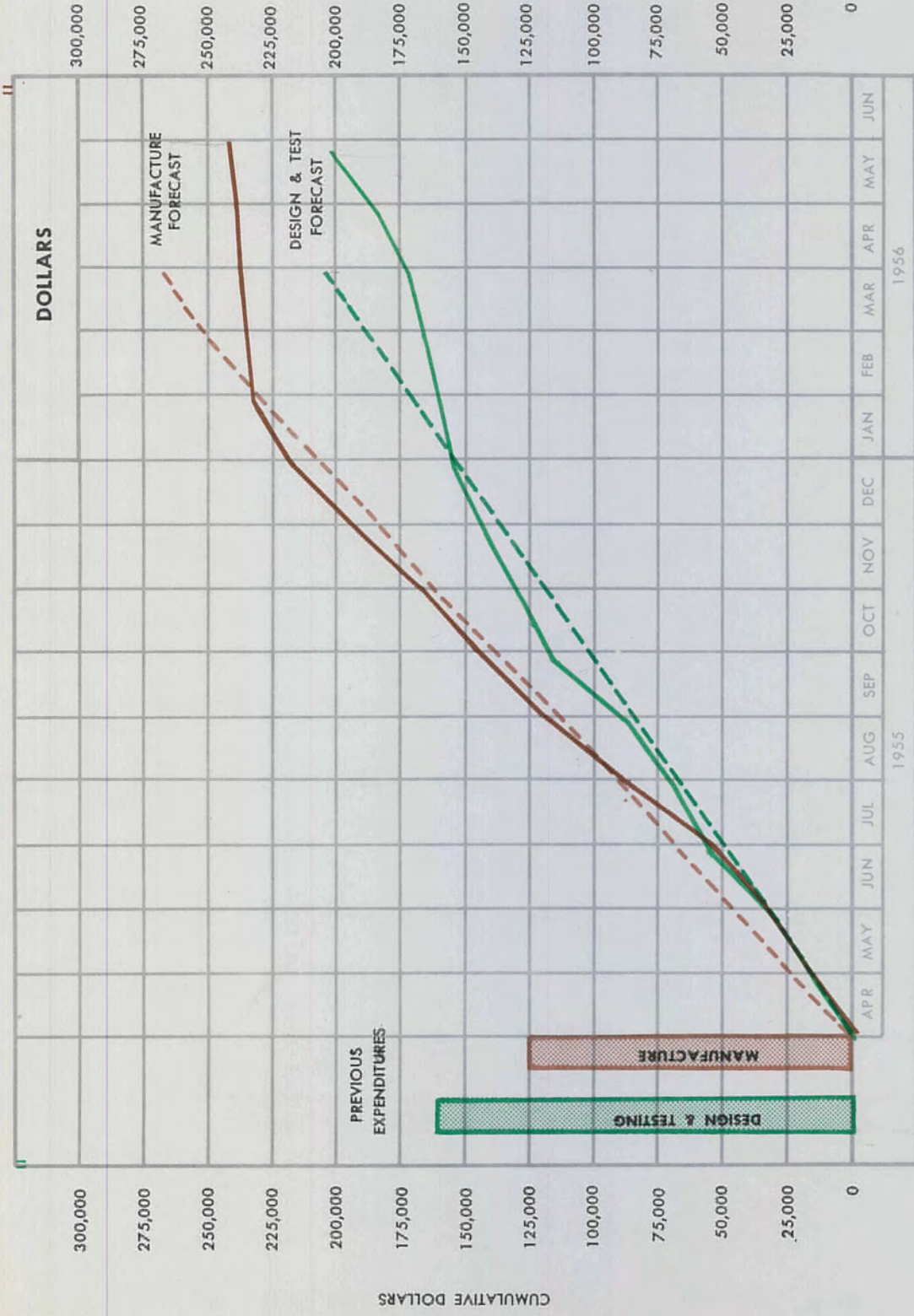


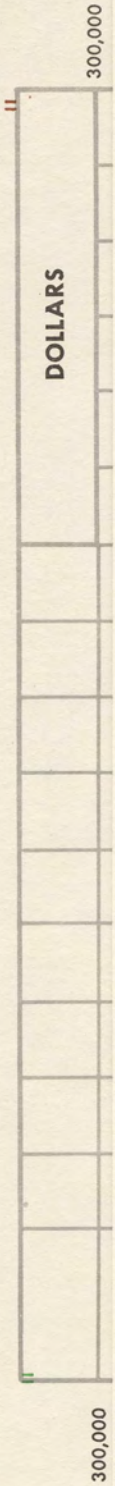
11

11









7. DEVELOPMENT AND PRODUCTION ASPECTS

Project 704 is much simpler to manufacture than more conventional type aircraft and can therefore be produced at a much lower cost. Due to its symmetry of form, there are a greater number of identical detail parts and component assemblies than there are in a conventional type of aircraft, Fig. 4, Page 7. This means that a much smaller range of tools is required to build the machine. Processing time is reduced and a very economical ratio of tools per detail part is achieved.

The airplane is broken down into six identical segments, each containing one of the Viper engines and each of which can be built in the same component jig. A single large jig can then be used to assemble the identical segments and these, when married up, constitute about 90% of the total airframe. The symmetry of form and repetitive construction leads to economy throughout development; not only is tooling economical but design, planning and all phases of development time are reduced.

Development of Project 704, as currently envisaged, is to proceed with the construction of a single prototype in the shortest possible time with only essential pre-flight development tests being carried out. The prototype will initially be constructed without the outer combustion; the initial test flying will be done "cold", proving the aircraft through the vertical take-off, ground cushion transition and low subsonic speed regimes. It is envisaged that development of the main combustion system will proceed concurrently however, and combustion will eventually be fitted to this

prototype aircraft which should then be capable of developing high thrust and reaching supersonic speed; but will be limited to a top speed of Mach 1.74 by the Viper engine.

Development of the full top speed potential is unlikely to be achieved until a second or third prototype has been completed. The subsequent aircraft may employ developed Viper engines or alternative power plants in a similar category and will probably be of all steel construction.

The first prototype will have a steel outer wing and steel main rotors and turbine, but the central portion of the aircraft will be constructed principally of light alloy. A programme of work covering the tests expected to be required, including a rig to cover the qualification of the power plant as a complete unit, is given in the next section.

8. NEW PROGRAMS REQUIRED

A tabular summary and cost forecast for the following is given in section 9.

8.1 Test Program

8.1.1 Wind Tunnel Tests

8.1.1.1 Supersonic Tests and Analysis - Overhaul and modify the existing 1/23rd scale supersonic force model. Re-design the air evacuation system, coordinate installation and conduct tests to complement the program already completed. Reduce data and prepare reports (approximately 60 hours tunnel time required).

Further testing is required on Supersonic Sting mounted 1/40 scale model to obtain transonic component drag data.

8.1.1.2 Transonic Tests and Analysis - Design and manufacture a half-plane transonic force model similar to the existing 1/6th scale subsonic and 1/23rd scale supersonic models. (A 1/12th scale model for installation in the 10 foot diameter transonic tunnel at Wright Air Development Centre is suggested). Design an installation rig to suit the tunnel facilities, complete with model control mounting, balance devices and suitable instrumentation for force and pressure measurements. Coordinate installation and conduct tests in accordance with a prepared program. Reduce data and prepare reports. (Approximately 200 hours tunnel time required).

8.1.1.3 Subsonic Tests and Analysis - Overhaul and modify the existing 1/6th scale subsonic force model and also the existing model control mounting and installation rig. Revise the instrumentation,

8.1.1.3
(Cont'd)

coordinate installation and conduct tests in the 20 foot Massie Memorial tunnel at Wright Air Development Centre to complement the program already completed. Reduce data and prepare reports. (Approximately 200 hours tunnel time required).

8.1.1.4 Internal Air Intake Flow Model - Design and manufacture an internal flow air intake model for development of the air intake flow up to the eye of the impeller. (A 1/5th scale half model (upper air intake only) for installation in the 10 foot diameter tunnel at the Wright Air Development Centre is suggested). Design and manufacture an installation rig to suit the tunnel facilities and instrumentation for pressure and mass flow measurements. Coordinate installation and conduct tests in accordance with a prepared program. Reduce data and prepare reports. (Approximately 50 hours tunnel time required).

8.1.1.5 Small Scale Wind Tunnel Tests - Design and manufacture small scale models as required for testing in the Company's 18" x 18" low subsonic and 8" x 11" supersonic wind tunnel. These tests will be of a minor nature and no general programme is envisaged at this time but data will be analysed and reports prepared.

8.1.2 Ground Effect Tests: Design and manufacture a 20" scale model incorporating discrete circumferential jets with air intake and centre exhaust, and an installation rig to suit the Company's air

- 8.1.2 (Cont'd) supply facilities, complete with balance devices and adjustable artificial ground. Conduct tests, reduce data and prepare reports.
- 8.1.3 Internal Flow Tests:
- 8.1.3.1 Air Intake Internal Flow - Design and manufacture a 1/5th scale internal flow half model (upper air intake only) for static suction tests, using a Viper engine at the Company's facility. Design a suitable installation rig and instrumentation for pressure and mass flow measurements. Conduct tests, reduce data and prepare reports.
- 8.1.3.2 Nozzle End Loss Test Model - Design and manufacture a 1/3rd scale internal flow model of an outer wing shutter segment, to suit the Company's air supply facility, and an installation rig with model mounting, balance devices and suitable instrumentation for force and pressure measurements. Conduct tests, reduce data and prepare reports.
- 8.1.3.3 Single Engine Intake and Exhaust Tests - Design and manufacture a reverse flow cascaded air intake duct and an engine exhaust full scale diffuser fantail, both for installation on the Viper engine at the Company's test facility. Design and manufacture suitable instrumentation for pressure and temperature measurement. Conduct tests, reduce data and prepare reports.
- 8.1.4 Propulsion System Tests and Qualification: Design, manufacture

8.1.4
(Cont'd)

and erect at the Company's facility a full scale 6 Viper test rig, consisting of a complete representative inner portion of the aircraft structure, together with the 6 engines and the upper and lower centrifugal impellers. This will include the complete inner wing assembly, the complete upper and lower fuel tank assemblies and the centre part of the upper and lower air intake assemblies.

Design and manufacture engine mountings, intakes, exhaust diffusers accessories location et al, to permit the installation of the 6 Viper gas turbine engines in the structure erection, and a fuel system to permit test operation of the 6 engines from the Company's test house.

Design and manufacture fire protection system; the control system to be capable initially of operating the 6 engines from the test house and ultimately from a temporary aircraft cockpit set up on the structure erection.

Design and manufacture the necessary electrical system capable of handling the engine accessories and fire protection control from the Company's test house, (and ultimately from the temporary aircraft cockpit).

Design and build a test site and test stand with suitable security and safety precautions at the Company's facility, complete with fuel storage and other services as may be required. Redesign and

8.1.4
(Cont'd)

modify, as necessary, the Company's existing test house.

Design and manufacture suitable instrumentation for pressure, mass flow and temperature measurements and engine impeller control. Provide for installation of the upper and lower centrifugal-impeller and turbine assemblies. Conduct tests in accordance with a prepared programme, reduce data and prepare reports.

Redesign and modify, as necessary, in the light of test results obtained, and conduct qualifying tests for experimental flying.

8.1.5 Control System Development Tests and Qualification:

8.1.5.1 Oscillation Rig and Shutter Box - Design and manufacture a jet control shutter testing rig with simulated aircraft control system, the control stick, or its equivalent, operated by a power driven oscillator, and using the Company's air supply facility. Conduct development tests of the shutter control system, as required, reduce data and prepare reports.

8.1.5.2 Outer Wing Segment and Control System - Design and manufacture a full scale outer wing segment assembly, including upper and lower shutters for installation on the full scale 6 Viper propulsion system test rig. Design and manufacture the aircraft shutter control system for installation in the outer wing segment, complete with main control valve and pilot stick in the temporary aircraft cockpit.

8.1.5.2
(Cont'd)

Design and manufacture a suitable oscillator and instrumentation for pressure and frequency measurements to connect to the pilot's stick.

Conduct tests in accordance with a prepared programme, reduce data and prepare reports. Redesign and modify, as necessary, in the light of test results obtained, and conduct qualifying tests for experimental flying.

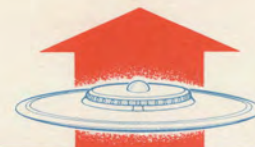
8.1.6 Combustor System Development:

Design and manufacture a combustion system testing rig, basically consisting of an outer wing segment containing one set of flame holders and one pair of nozzles to be tested at Orenda Engines Limited, Nobel facility. Design and manufacture a suitable fuel system, with control system and storage. Provide suitable instrumentation for the measurement of pressure temperature and mass flow. Conduct tests in accordance with a prepared programme, reduce data and prepare reports. Redesign and modify as necessary in the light of test results obtained and conduct qualifying tests for experimental flying.

8.2 Design Study and Theoretical Analysis

The following design study and theoretical analyses are considered appropriate to the next phase of development.

8.2.1 Weapon System Design Studies: Carry out preliminary design study



8.2.1
(Cont'd)

to apply the AVRO AIRCRAFT LIMITED vertical take-off design concept to the following weapon systems:

- (i) Reconnaissance
- (ii) Interceptor
- (iii) Tactical Bomber

Prepare reports which will include drawings showing suitable space provision for carrying equipment appropriate to the above roles, weight analysis to include such equipment and performance data. The latter will demonstrate speed and altitude capability, take-off landing and turning performance and range profiles with appropriate allowances and payload.

8.2.2 Weapon System Development Plan: Prepare a report giving estimated timing and costs for the manufacture and development of prototype reconnaissance aircraft broadly as specified by (i) above. The report will specify and describe the aircraft, material facilities and tests required in accordance with ARDC M80-4, and give data on the ability of AVRO AIRCRAFT LIMITED to carry out the Development Plan.

8.2.3 Stability and Control Analysis: Analyse and determine the flight behaviour of the aircraft in response to gusts or pilot demand over the whole flight range, using available wind tunnel data and mechanical component performance as obtained from tests described in section 8.1.5.



8.2.4 Propulsion System Analysis: Extend the existing propulsion system analysis to cover the off-design performance of the system using data obtained from tests under 8.1.3 above, measured flow characteristics for the Viper engines and more comprehensive analysis of expected power turbine characteristics.

PROJECT 1794

DEVELOPMENT SUMMARY TABLE - JUNE 1st, 1956

TESTS AND ANALYSES COMPLETED

Ref. Para	Item - Location	Ref. Page	Results and Remarks
5.1	<u>TESTS</u>	20	
	<u>Wind Tunnel Models</u>		
5.1.1	Subsonic 1/6 scale with jets and intake in MMWT at W. A. D. C. - Dayton	20	Good results obtained from transition and in-flight tests with jet control. Considerable induced lift and moment produced by distributed jet, and data is reliable. Drag data still subject to some doubt.
5.1.1.2	Supersonic Sting mounted 1/40 scale in N. S. L. at M. I. T., - Boston	28	Satisfactory drag agreement with estimate obtained.
	Supersonic 1/23 scale with jets and intake in N. S. L. at M. I. T., - Boston	28	Satisfactory drag agreement with estimate obtained. Some doubt because of limited air intake suction. Good results for lift and moment with considerable induced effects from distributed jet. Very good Supersonic L/D ratio obtained.
	Supersonic 2/25 scale air intake pressure recovery	33	Very good pressure recovery obtained over wide range of angle of attack and Mach no. Problem of thick boundary layer spill over at sides should be soluble by ramp modification.



TESTS AND ANALYSES COMPLETED (Cont'd)

Ref. Para	<u>Item - Location</u>	Ref. Page	<u>Results and Remarks</u>
5. 1. 1. 3	Preliminary Subsonic Transition and trim at Avro Aircraft	41	Satisfactory preliminary results.
	Preliminary Supersonic trim at Avro Aircraft	41	Satisfactory preliminary results.
	Dynamic Stability Models at Avro Aircraft	41	Satisfactory behaviour observed.
	Air Intake Internal flow at Avro Aircraft	41	Flow distribution not satisfactory. Further development tests required.
5. 1. 2	<u>Air Cushion Effect Tests</u>	54	
	10" diameter models on static rig at Avro Aircraft	54	Powerful air cushion effect confirmed. Up to 1.8 times thrust at nearly half a span.
	20" diameter models on static rig at Avro Aircraft	54	Doubt exists on value of free air thrust so effect may be improved. Lower surface air intake does not destroy ground cushion.
	Delta Wing model tests at Avro Aircraft	54	Delta wing gave poor air cushion.
	Hot central Jet Tests at Avro Aircraft	54	Satisfactory evidence that warming of lower intake air can be avoided.

TESTS AND ANALYSES COMPLETED (Cont'd)

Ref. Para	<u>Item - Location</u>	Ref. Page	<u>Results and Remarks</u>
5.1.2	1/6 scale Subsonic Model static (Cont'd) tests at W. A. D. C. in Dayton.	54	Still doubt on value of free air thrust. Otherwise effect satisfactory. Control data obtained.
5.1.3	<u>Stability and Control Tests</u>	65	Collection of aerodynamic data from wind tunnel models as above.
5.1.4	<u>Air Intake and Gas Exhaust System</u>	67	Low diffuser pressure drop. Test piece became obsolete.
5.1.4.1	45° Segment Test, at Avro Aircraft, Malton	67	Considerable thrust is recovered with exterior bending through 90°. Moments are nearly twice jet reaction.
5.1.4.2	Thrust recovery test at Orenda Engines, Nobel, Ont.	70	Moderate loss found.
5.1.4.3	End Loss Test	73	

TESTS AND ANALYSES COMPLETED (Cont'd)

Ref. Para	Ref. Page	Results and Remarks	Total Costs Per Item Inc. Tests in 5.1
5.2	74	<u>DESIGN STUDY AND THEORETICAL ANALYSIS</u>	
5.2.1	74	Air Cushion effect Theory does not explain observations sufficiently accurately.	\$ 54,446.41
5.2.2	76	Stability and Control Conventional handling should be possible. Controls adequate for stabilization.	\$329,493.64
5.2.3	77	Air Intake and Gas Exhaust Tests only.	\$290,853.24
5.2.4	78	Performance Estimated performance has improved M = 3.0; 94,000 ft. and 1000 n. mi. range at conventional engine temperature.	\$ 30,713.72
5.2.5	78	Radial Flow Feasibility Considerable design study has evolved concept now being built.	\$ 36,311.98
		Grand Total to date	<u>\$741,818.99</u>
		Balance \$19,824. will be expended on the preparation of Reports during the month of June 1956.	

TABULATED SUMMARY & COST FORECAST FOR NEW PROGRAMS REQUIRED

9.1 TEST PROGRAM

<u>Item and Suggested Location</u>	<u>Ref. Page</u>	<u>Remarks</u>	<u>Cost Forecast</u>
9.1.1 <u>Wind Tunnel Models</u>	98		
9.1.1.1 Subsonic 1/6 Scale with intake jets in MMWT at W.A.D.C. in Dayton	98	Required for lower speed transition, hot jet tests, surface pressures and further drag investigation.	\$135,000.00
9.1.1.2 Supersonic Sting mounted 1/40 scale in N.S.L. at M.I.T. in Boston	98	Required for transonic component drag data.	\$ 86,000.00
Supersonic 1/23 scale with jets and intake in N.S.L. at M.I.T. - Boston	98	Complementary program to 5.1.1.2 also to obtain full intake suction.	
9.1.1.3 Transonic 1/12 scale in 10 ft. Tunnel at W.A.D.C. in Dayton	98	Basic transonic force model with flow simulation.	\$223,000.00
9.1.1.4 Air Intake internal flow 1/5 scale in 10 ft. Tunnel at W.A.D.C. in Dayton	99	Development Model.	\$115,000.00
9.1.1.5 Minor small scale tests at Avro Aircraft	99	Number of models to be decided later.	---
9.1.1.2 <u>Ground Effect Tests</u>	99	New rig required capable of simulating exact take-off condition for 6-Viper aircraft.	\$ 52,000.00



TABULATED SUMMARY & COST FORECAST FOR NEW PROGRAMS REQUIRED (Cont'd)

<u>Item and Suggested Location</u>	<u>Ref. Page</u>	<u>Remarks</u>	<u>Cost Forecast</u>
9.1.1.3 <u>Internal Flow Tests</u>	100		
9.1.1.3.1 Static 1/5 scale air intake internal flow at Avro Aircraft	100	Precedes 9.1.1.4.	\$ 75,000.00
9.1.1.3.2 Static 1/3 scale nozzle end loss, at Avro Aircraft	100	Loss is unpredictable therefore large scale test required.	\$ 68,000.00
9.1.1.3.3 Single engine intake and exhaust characteristics at Avro Aircraft	100	Full scale development.	\$ 66,000.00
9.1.1.4 <u>Propulsion System Test and Qualification</u>	100	6-Viper propulsion system development rig complete with all ancillaries.	\$1,570,000.00 (Excluding Tooling)
9.1.1.5 <u>Control System Development and Qualification</u>	102		
9.1.1.5.1 Oscillation rig and Shutter box	102	Initial response measurements and shutter development.	\$ 120,000.00
9.1.1.5.2 Outer wing Segment and Control System	102	Fitted to 6-Viper test rig.	\$ 216,000.00 (Excluding Tooling)
9.2 <u>DESIGN STUDY AND THEORETICAL ANALYSIS</u>	103		
9.2.1 <u>Weapon System design study</u> (Extent of this study to be determined upon receipt of A. R. D. C. Manual 80-4 dated July 1, 1955)	103	Drawings and performance including trade data, as: (1) Reconnaissance (2) Interceptor (3) Tactical bomber	\$ 70,000.00

TABULATED SUMMARY & COST FORECAST FOR NEW PROGRAMS REQUIRED (Cont'd)

<u>Item and Suggested Location</u>	<u>Ref. Page</u>	<u>Remarks</u>	<u>Cost Forecast</u>
9.2.2 Combustor Development and test	103	Design, develop, test and report.	\$ 200,000.00
9.2.3 Weapon System development plan study (Note: 9.2.1 also applies)	104	Report on development of reconnaissance aircraft.	\$ 94,000.00
9.2.4 Stability and Control Analysis	104	Response of aircraft based on component test and tunnel data.	\$ 39,000.00
9.2.5 Propulsion System Analysis	105	Performance 'off-design' and using test results from 8.1.3.3 etc.	\$ 39,000.00
Total Forecast			<u>\$3,168,000.00</u>

This "Cost Forecast" has been compiled by Special Projects Group in accordance with their interpretation of Exhibit '1' Statement of Work Project 1794 (Preliminary Draft) dated May 1, 1956.